

# Mod-Guard

# PERIMETER GUARD SYSTEMS

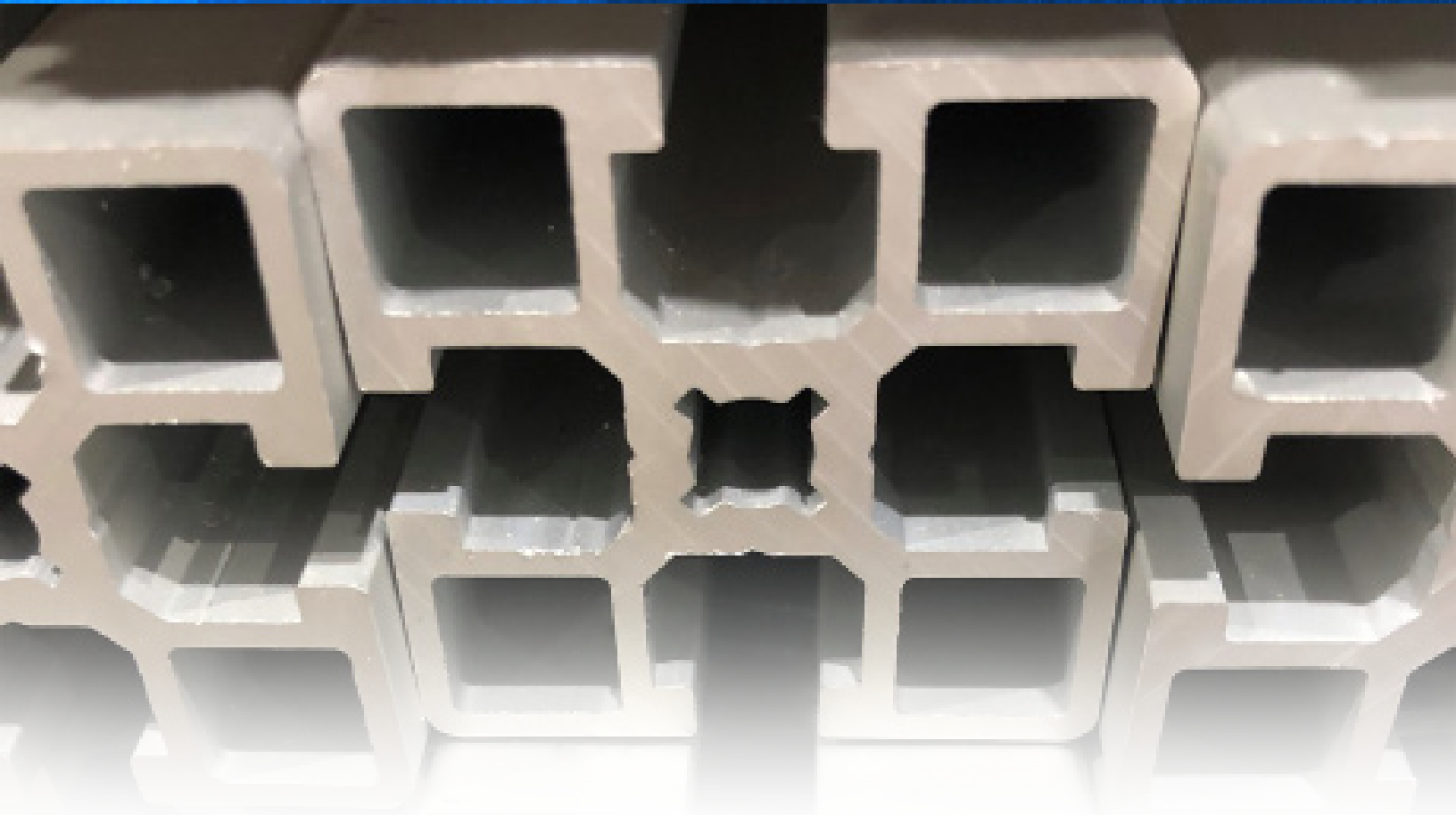







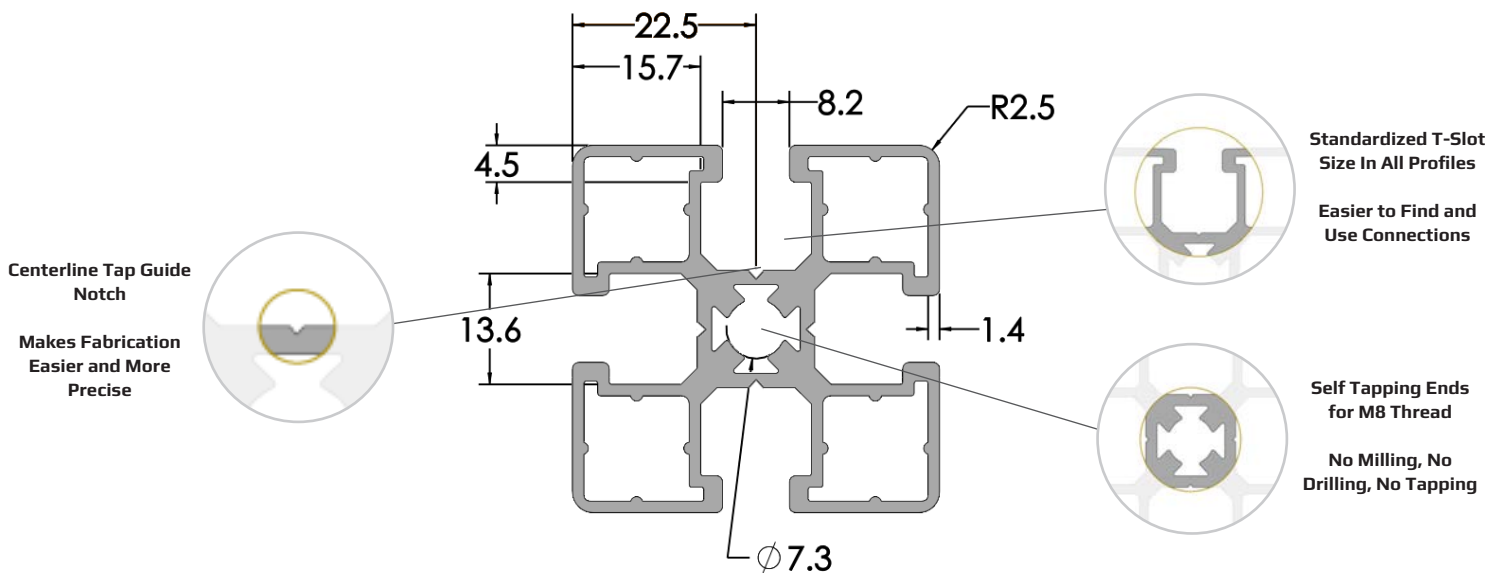





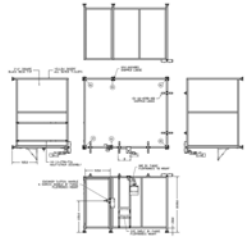
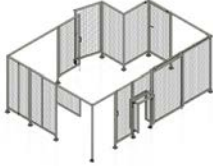
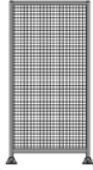
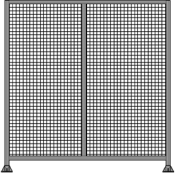

## A Notch Above the Rest

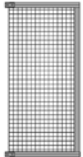
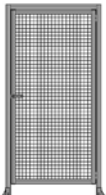
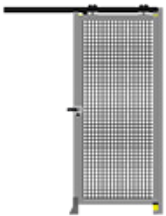
Many of our profiles come standard with centerline tap guide notches, self tapping ends and common T-slot size for easy fabrication and installation.

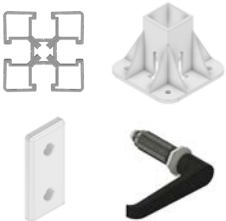
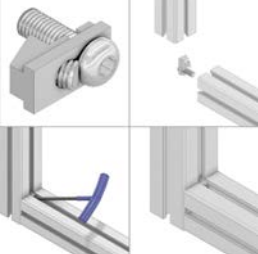

## Table of Contents

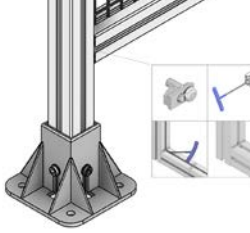
				
<p>Page 1 The Modular Solutions Advantage</p>	<p>Page 2 Different Ways to Order</p>	<p>Page 3 Design Process</p>	<p>Page 4 Modular Wall Sections Overview</p>	<p>Pages 5-7 How to Order Type A Single Panels</p>
				
<p>Pages 8-10 How to Order Type B Double Panels</p>	<p>Pages 11-13 How to Order Type C Double Wall Corners</p>	<p>Pages 14-16 How to Order Type D Dog Houses</p>	<p>Pages 17-20 How to Order Type E Removable Panels</p>	<p>Pages 21-23 How to Order Type F Wings</p>
				
<p>Pages 24-27 How to Order Type G Swing Doors</p>	<p>Pages 28-31 How to Order Type H Sliding Doors</p>	<p>Pages 32-35 How to Order Type J Double Swing Doors</p>	<p>Pages 36-37 How to Order Type K Post</p>	<p>Pages 38-40 How to Order Type L Bar and Half Strap</p>
				
<p>Pages 41-43 Hardware and Tools</p>	<p>Pages 44-47 Accessory Parts</p>	<p>Page 48 Component Integration</p>	<p>Page 49 Online Configurator</p>	<p>Page 50 Self Assembly and Install Team Options</p>



**EASY**



**FAST**



**AFFORDABLE**



**STANDARDIZED**



### Speed

- Quick guard solution – Free 3D models, quick part number generation, and extremely fast quotes.
- 5 day turn on all standard assemblies (out of the how to order guide).
- Industry standard guarding.
- 45MM square posts, with yellow signal insert.
- 1" x 1" – 12 AWG welded wire mesh with a PVC coating.
- Hidden fasteners to prevent tampering.

### Affordable

- Dedicated and focused solely on guarding reduces our overall expense, vs. offering hundreds of different extrusions.
- Standardized product, configurations, and quick design tools, allow for MGS to be one of the most competitively priced vendors in the market.
- Domestically sourced material have also greatly reduced or expensive associated with shipping and importing foreign products.

### Quality

- Precision cutting - Our state-of-the art, high precision upcut saw (calibrated monthly to 1/10mm) cuts profiles to length.
- Our extrusions exceeds the aluminum association standard tolerances for all profiles.
- All profile are made with 6063-T6 aluminum and has a clear anodized surface finish.

### Local

- Aluminum extrusion is made in the USA.
- Standard inventory for quick turn around.
- On-site installation is available.
- Our design engineers are highly skilled to assist in your design requirements.

### Service

- Dedicated customer service agents that can assist you in your part number development.
- Outside sales staff for on-sight visits and demonstrations.
- Engineering and designers on staff to handle your unique applications.
- Samples and demos are available upon request.

## Complete Assemblies

Most of our customers utilize our talented sales team and innovative engineers to help take your ideas and produce a finished product in the shortest time. These complete solutions range from basic guards to complex automation systems. Complete solutions are designed and built and shipped direct to your door.

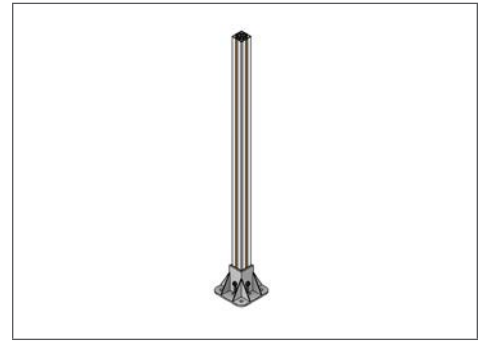
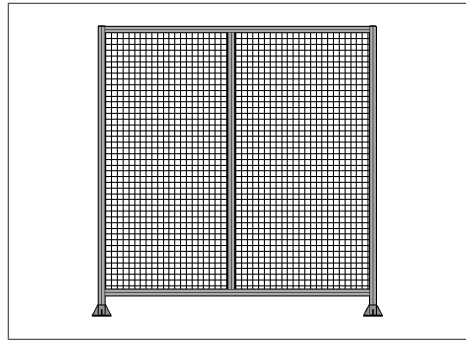
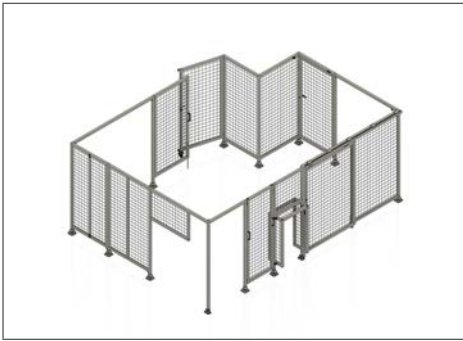

## Kits

Want to assemble the product yourself?

Our sales team and engineers will help as with complete solutions but to let your tradesmen do the final assembly. We will furnish a kit with all parts and assembly drawings. Kits can be more easily shipped than complete assemblies.

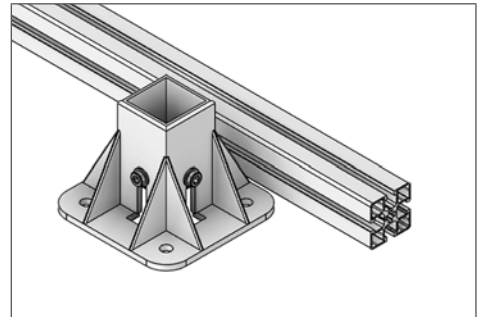
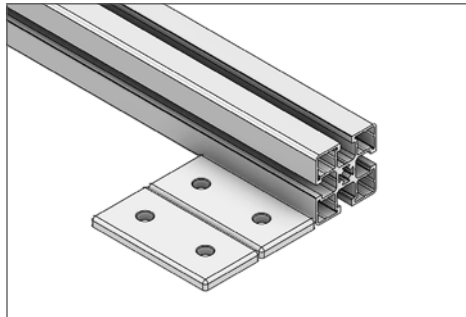
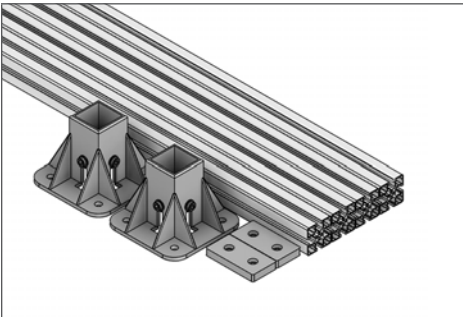

## Bulk Purchases

You can order profile in full stick lengths for your total control of cutting to length, machining and assembly. Fasteners, hinges, wheels and other accessories are also available in bulk purchases. Purchasing parts can be the most cost effective approach if you are equipped for design, machining and assembly. Our large inventory will allow us to ship just what you need to your door.

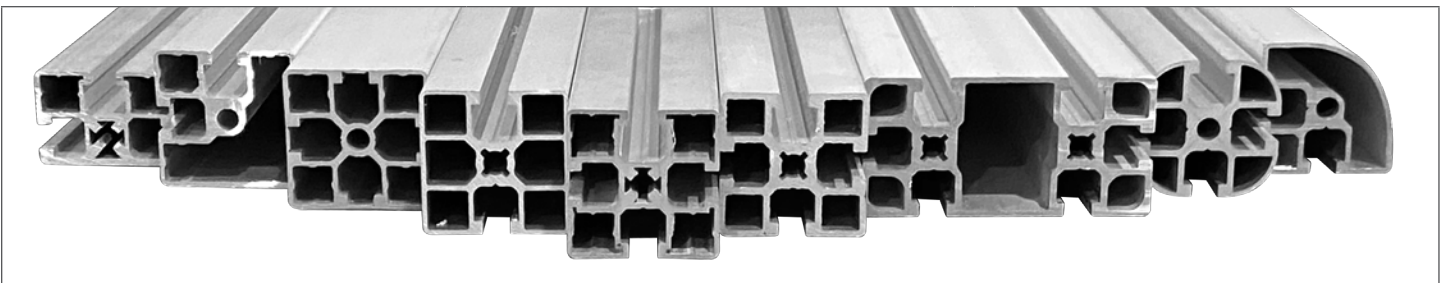

## Build to Print / Engineered Solutions

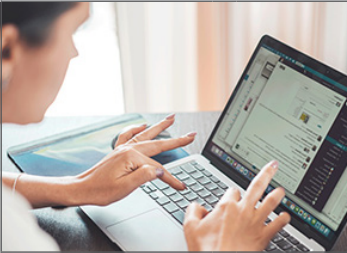

Send us a DWG, Step or PDF of your design and our engineers and sales staff will support you with your needs.

Step 1 – Customer supplied drawing and consultation with a sales engineer.

Step 2 – We will provide a quote and 3D drawing.

Step 3 – After order is placed we will provide 3D Model for design approval.

Step 4 – With the shipment we will provide an assembly print for your install team.

### Step 1: Customer Supplies Drawings

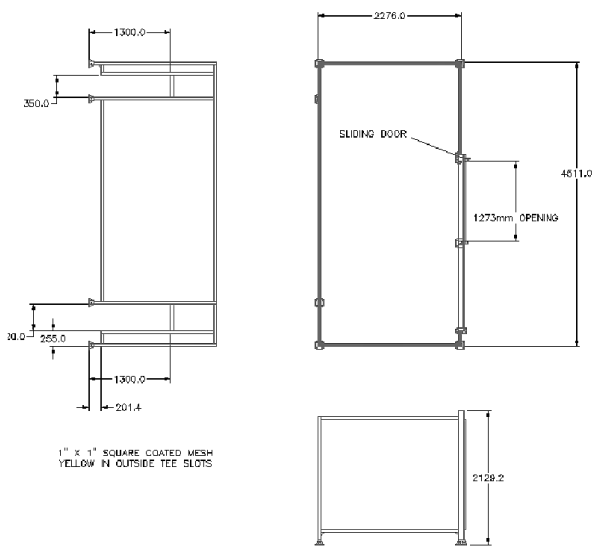

### Step 2: We Provide 3D Models for Approval

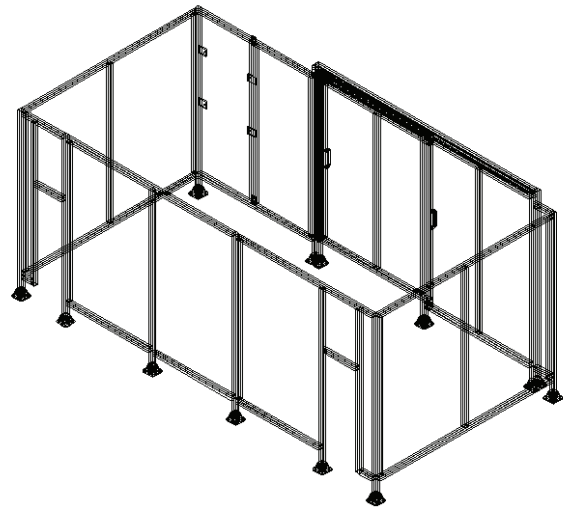

### Step 3: We Make Assembly Models for Installation

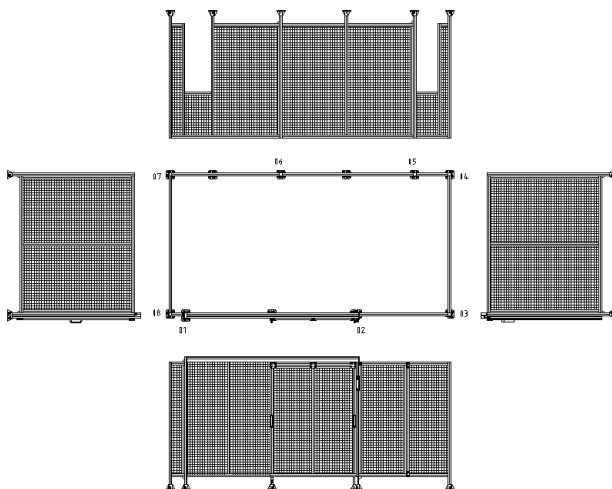

### Step 4: We Provide Assembly Print With Shipment

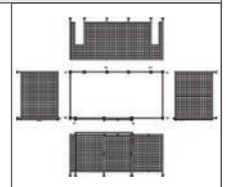

Modular Guarding Solutions offers easy to configure guarding wall sections. Each section features its own how to order guide in this catalog.

You can also go to [www.Mod-Guard.com](http://www.Mod-Guard.com) to configure solid models or PDF data sheets.

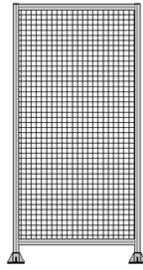

**Single Panel A**  
Pages 12-13

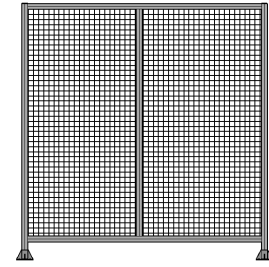

**Double Panel B**  
Pages 14-15

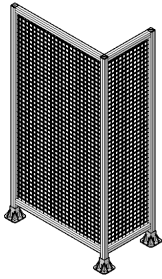

**Double Wall Corners C**  
Pages 16-17

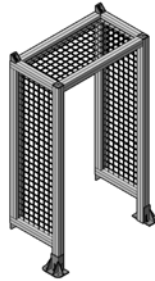

**Dog Houses D**  
Pages 18-19

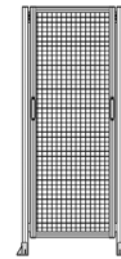

**Removable Panel E**  
Pages 20-21

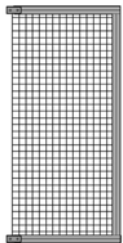

**Wings F**  
Pages 22-23

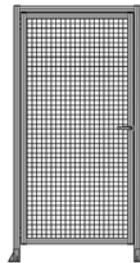

**Swing Doors G**  
Pages 24-25

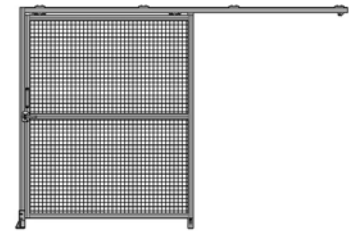

**Sliding Doors H**  
Pages 26-27

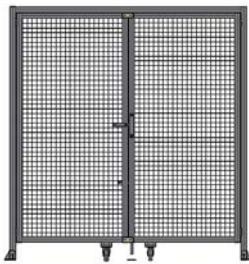

**Double Swing Doors J**  
Pages 28-29



**Post K**  
Page 30



**Bar L**  
Page 31

## How to Order

<b>A1</b>	<b>-</b>	<b>1000</b>	<b>-</b>	<b>1000</b>	<b>-</b>	<b>0150</b>	<b>-</b>	<b>T</b>	<b>Y</b>	<b>M</b>	<b>F</b>	<b>A</b>
Type		Height		Width		Sweep		Connection	Insert	Panel	Foot	Assembly

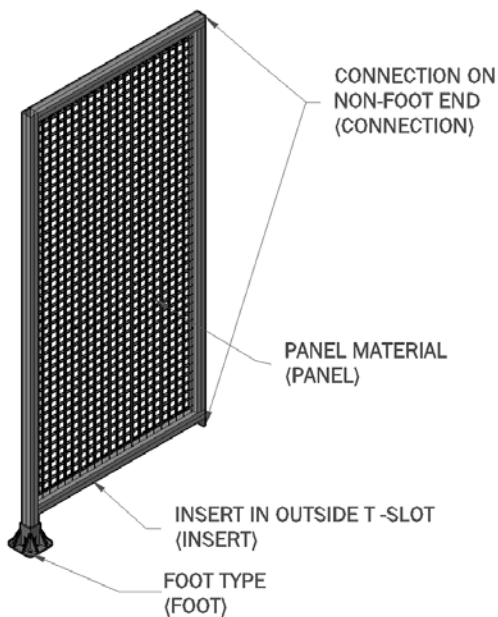
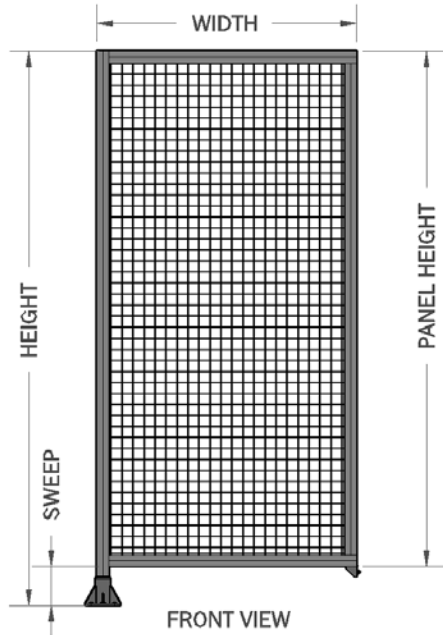

Guard Type (Type)
A1 - Leg on Left
A2 - Leg on Right
A3 - Leg on Both Sides
A4 - No Legs
Ref view from outside cell

Height
Height of Guard (MM) Measured from bottom of foot to top of the guard Max panel height - sweep = 2400MM

Width
Width of guard (MM) Measure from outside edge to outside edge Max length is 1200MM

Sweep
Sweep of Guard (MM) Measured from bottom of foot to bottom of the guard Sweep = Height - panel height

Connection Non-Foot End (Connection)
T - Tie Plates Top, Angle at Bottom Tie plate good for straight connection
P - Tie Plates Top and Bottom Good for adding a panel to a fence section
A - 45 Degree Angle on Top and Bottom Angle good for 90 degree wall connections
H - Hinge Hinge good for odd angle connection
Z - No Connection Standard on A3

Insert
Y - Yellow Insert
O - Orange Insert
Z - None
Powder coated extrusion available on request

Panel Material (Panel)
M - 1" x 1" Mesh
U - Blue - 1/4" PVC Board
G - Grey - 1/4" PVC Board
B - Black - 1/4" PVC Board
W - White - 1/4" PVC Board
P - 1/4" Polycarbonate
L - Aluminum Composite Paneling
C - 0.090 Aluminum Panel - Not Coated
R - No Panel with Retainer Insert
N - No Mesh with Retainer Insert
Z - No Panel
Other panels, mesh, and colors available upon request

Foot Type (Foot)
F - Four Sided Foot Min sweep >150MM
T - Three Sided Foot Can be adjusted at install
P - 2" Pad and Angle Bar
A - Single Small Angle 45 x 90
Z - No Foot

Assembled or Kit (Assembly)
A - Assembled Factory assemblies
K - Kit Customer assemblies



## Single Panel Guard Types

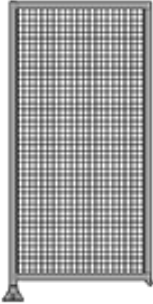

**A1 - Leg on Left**

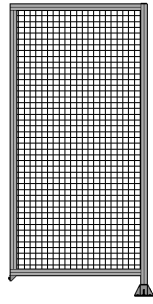

**A2 - Leg on Right**

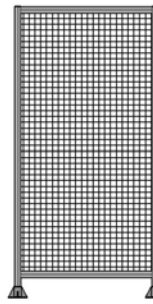

**A3 - Leg on Both Sides**

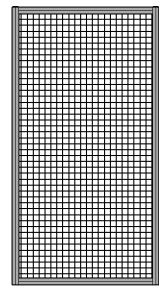

**A4 - No Legs**

## Connection Options

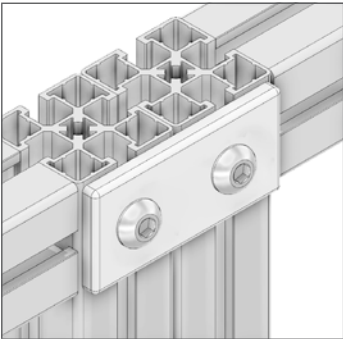

**T, P - Tie Plate**  
45MM x 90MM plate for connecting two pieces of 45MM wide profile together.

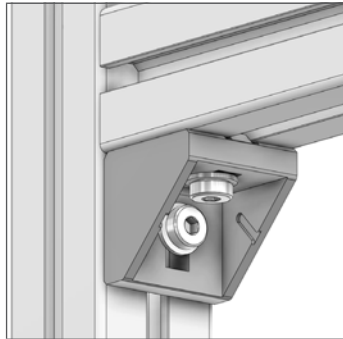

**A - 45 Degree Angle**  
90 degree angle 45MM wide x 45MM deep. Angle bracket used for connecting two pieces of 45MM wide profile together.

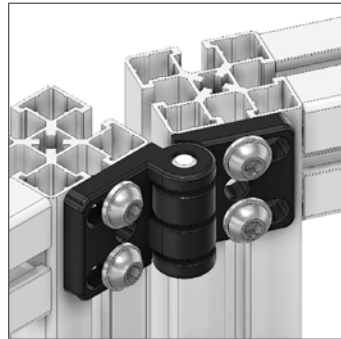

**H - Hinge**  
Externally mounted hinge for connecting two wall panels together for 45MM wide profile.

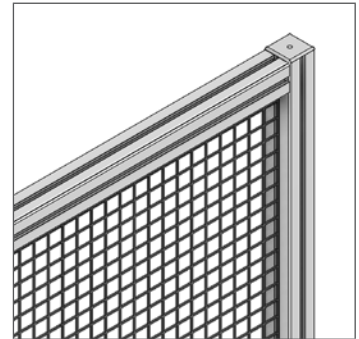

**Z - No Connection**  
No connections on the non-foot end.

## Insert Options

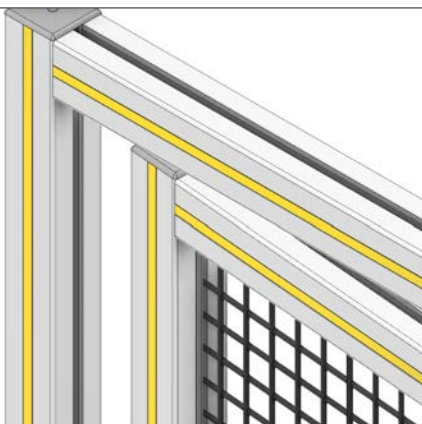

**Y - Yellow Insert**  
Yellow plastic cover will be inserted in the outside T-slot to keep T-slot clear of debris and indicate safety fence zone for many customers standards. Goes in the outside face of the fence's T-slot.

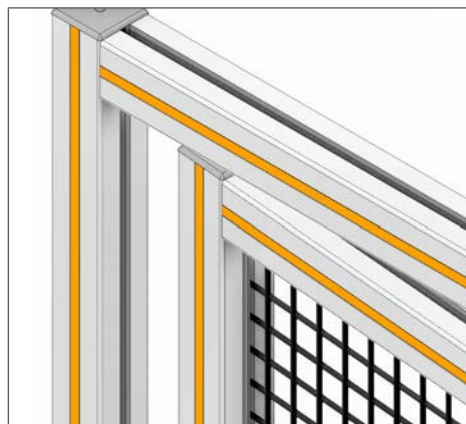

**O - Orange Insert**  
Orange plastic cover will be inserted in the outside T-Slot to keep T-slot clear of debris and indicate a zone. Goes in the outside face of the fence's T-slot.

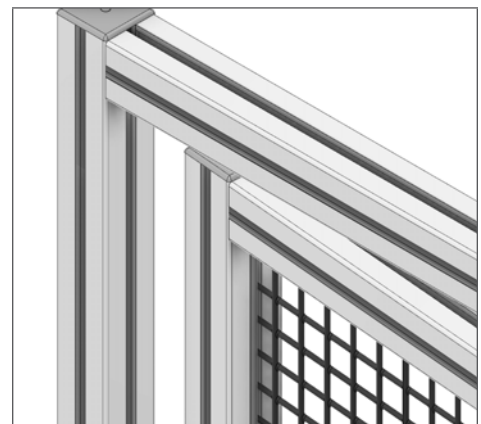

**N - None**  
No plastic cover inserted into the T-slot.

## Panel Material



**M - Mesh**

1" x 1" 12AWG welded wire mesh, with a PVC coating, and a pattern of 1" x 1" on the wire center lines.



**P - Polycarbonate**

¼" clear paneling made of polycarbonate material.

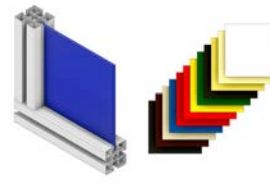

**U, G, B, W - PVC Board**

PVC foam board compressed for a smooth surface and light weight material. Comes in a large variety of colors. White, blue, black, and gray are our standards, but many others are available.



**L - Aluminum Composite Panel**

Aluminum board with a painted silver metallic surface and a plastic corrugated core.



**C - Aluminum Panel**

Solid 0.09" non-anodized aluminum paneling.



**R - No Panel with Retainer Insert**

This is a plastic insert commonly used to hold ¼" paneling into the T-slot.



**N - No Mesh with Retainer Insert**

This is a plastic insert commonly used to hold 1" mesh into the T-slot.



**Z - No Panel**

## Foot Types



**F - Four Sided Foot**

Standard foot with pad and anchor points on all four side of the post where it touches the ground. 9MM diameter mounting holes.

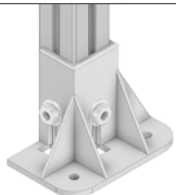

**T - Three Sided Foot**

Foot with pad and anchor points on three of the four sides of the guard. Comes standard on doors with flush side in the door. Comes standard on guard with flush side on inside of guard. Can easily be field rotated.



**P - 2" Pad and Angel Bar**

Leveling pad with 2" surface, and angle bar for providing an anchor point.



**A - Single Small Angle**

90 Degree Angle, 45MM wide x 90MM long/tall for a single simple anchor point.

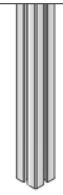

**Z - No Foot**

Aluminum profile go to the floor - No support or anchor point.

## Assembled or Kit

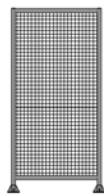

**A - Assembled**

We build the fence sections to the print.

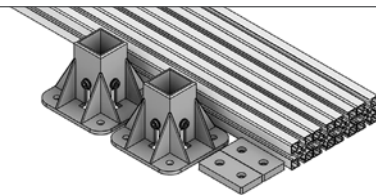

**K - Kit**

Typically, a lower cost alternative where the customer will assemble the wall section themselves.

## How to Order

<b>B1</b>	-	<b>2200</b>	-	<b>2200</b>	-	<b>0150</b>	-	<b>T</b>	<b>Y</b>	<b>M</b>	<b>F</b>	<b>A</b>
Type		Height		Width		Sweep		Connection	Insert	Panel	Foot	Assembly

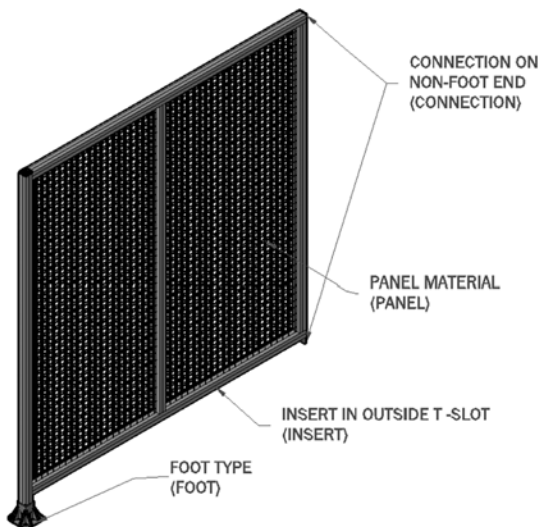
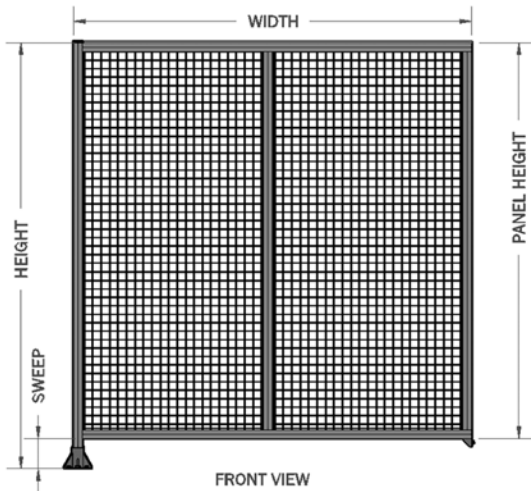

Guard Type (Type)
B1 - Single Leg on Left
B2 - Single Leg on Right
B3 - Legs on Both Sides
B4 - No Legs
B5 - Leg on Left and In Center
B6 - Leg on Right and In Center
B7 - One Leg In Center
B8 - Three Legs
Ref View from Outside Cell

Height
<b>Height of Guard (MM)</b> Measured from bottom of foot to top of the guard Max panel height - sweep = 2400MM

Width
<b>Width of Guard (MM)</b> Measure from outside edge to outside edge Max length is 1200MM

Sweep
<b>Sweep of Guard (MM)</b> Measured from bottom of foot to bottom of the guard Sweep = Height - panel height

Connection Non-Foot End (Connection)
T - Tie Plates Top, Angle at Bottom Tie plate good for straight connection
P - Tie Plates Top and Bottom Good for adding a panel to a fence section
A - 45 Degree Angle on Top and Bottom Angle good for 90 degree wall connections
H - Hinge Hinge good for odd angle connection
Z - No Connection Standard on A3

Insert
Y - Yellow Insert
O - Orange Insert
Z - None
Powder coated extrusion available on request

Panel Material (Panel)
M - 1" x 1" Mesh
U - Blue - 1/4" PVC Board
G - Grey - 1/4" PVC Board
B - Black - 1/4" PVC Board
W - White - 1/4" PVC Board
P - 1/4" Polycarbonate
L - Aluminum Composite Paneling
C - 0.090 Aluminum Panel - Not Coated
R - No Panel with Retainer Insert
N - No Mesh with Retainer Insert
Z - No Panel
Other panels, mesh, and colors available upon request

Foot Type (Foot)
F - Four Sided Foot Min sweep >150MM
T - Three Sided Foot Can be adjusted at install
P - 2" Pad and Angle Bar
A - Single Small Angle 45 x 90
Z - No Foot

Assembled or Kit (Assembly)
A - Assembled Factory assemblies
K - Kit Customer assemblies

## Double Panel Guard Types

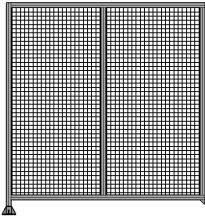

**B1 - Single Leg on Left**

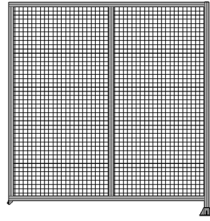

**B2 - Single Leg on Right**

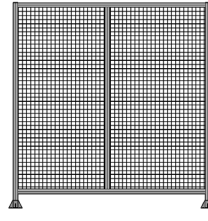

**B3 - Legs on Both Sides**

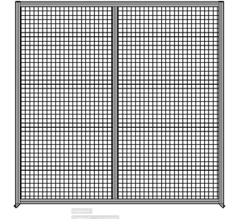

**B4 - No Legs**

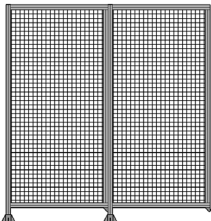

**B5 - Leg on Left and in Center**

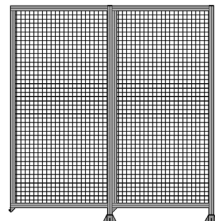

**B6 - Leg on Left and in Center**

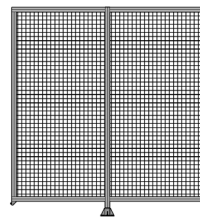

**B7 - One Leg in Center**

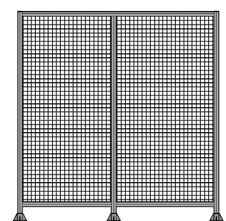

**B8 - Three Legs**

## Connection Options

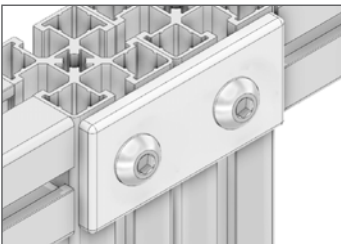

**T, P - Tie Plate**  
45MM x 90MM plate for connecting two pieces of 45MM wide profile together.

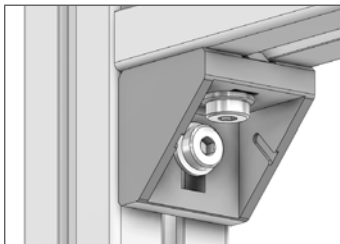

**A - 45 Degree Angle**  
90 degree angle 45MM wide x 45MM deep. Angle bracket used for connecting two pieces of 45MM wide profile together.



**H - Hinge**  
Externally mounted hinge for connecting two wall panels together for 45MM wide profile.

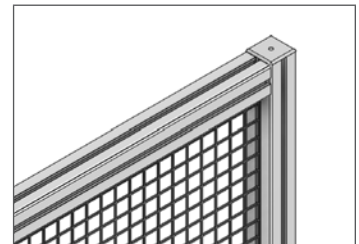

**Z - No Connection**  
No connections on the non-foot end.

## Insert Options

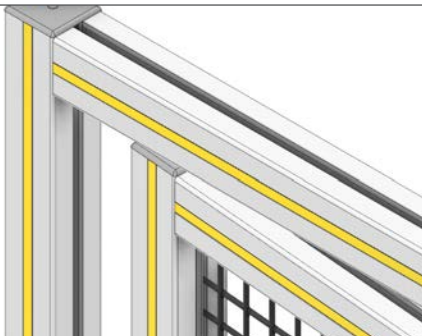

**Y - Yellow Insert**  
Yellow plastic cover will be inserted in the outside T-slot to keep T-slot clear of debris and indicate safety fence zone for many customers standards. Goes in the outside face of the fence's T-slot.

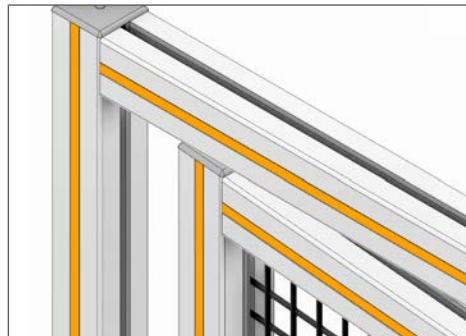

**O - Orange Insert**  
Orange plastic cover will be inserted in the outside T-Slot to keep T-Slot clear of debris and indicate a zone. Goes in the outside face of the fence's T-slot.

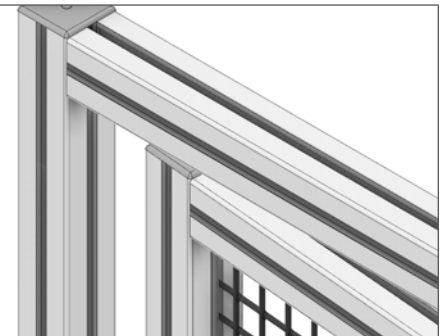

**N - None**  
No plastic cover inserted into the T-slot.

## Panel Material



**M - Mesh**  
1" x 1" 12AWG welded wire mesh, with a PVC coating, and a pattern of 1" x 1" on the wire center lines.



**P - Polycarbonate**  
¼" clear paneling made of polycarbonate material.

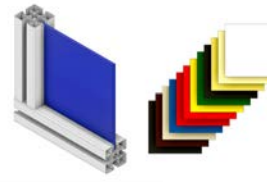

**U, G, B, W - PVC Board**  
PVC foam board compressed for a smooth surface and light weight material. Comes in a large variety of colors. White, blue, black, and gray are our standards, but many others are available.



**L - Aluminum Composite Panel**  
Aluminum board with a painted silver metallic surface and a plastic corrugated core.



**C - Aluminum Panel**  
Solid 0.09" non-anodized aluminum paneling.



**R - No Panel with Retainer Insert**  
This is a plastic insert commonly used to hold ¼" paneling into the T-slot.



**N - No Mesh with Retainer Insert**  
This is a plastic insert commonly used to hold 1" mesh into the T-slot.



**Z - No Panel**

## Foot Types



**F - Four Sided Foot**  
Standard foot with pad and anchor points on all four sides of the post where it touches the ground. 9MM diameter mounting holes.

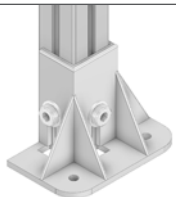

**T - Three Sided Foot**  
Foot with pad and anchor points on three of the four sides of the guard. Comes standard on doors with flush side in the door. Comes standard on guard with flush side on inside of guard. Can easily be field rotated.



**P - 2" Pad and Angel Bar**  
Leveling pad with 2" surface, and angle bar for providing an anchor point.



**A - Single Small Angle**  
90 degree angle, 45MM wide x 90MM long/tall for a single simple anchor point.

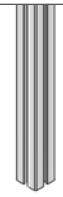

**Z - No Foot**  
Aluminum profile go to the floor. No support or anchor point.

## Assembled or Kit

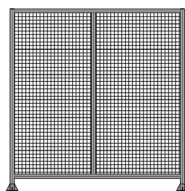

**A - Assembled**  
We build the fence sections to the print.

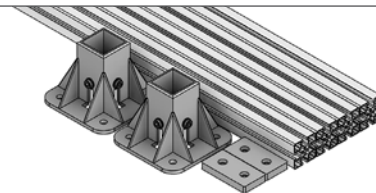

**K - Kit**  
Typically, a lower cost alternative where the customer will assemble the wall section themselves.

## How to Order

<b>C1</b>	<b>-</b>	<b>1000</b>	<b>-</b>	<b>1000</b>	<b>-</b>	<b>1000</b>	<b>-</b>	<b>0150</b>	<b>-</b>	<b>T</b>	<b>Y</b>	<b>M</b>	<b>F</b>	<b>A</b>
-----------	----------	-------------	----------	-------------	----------	-------------	----------	-------------	----------	----------	----------	----------	----------	----------

Type      Height      Width1      Width2      Sweep      Connection      Insert      Panel      Foot      Assembly

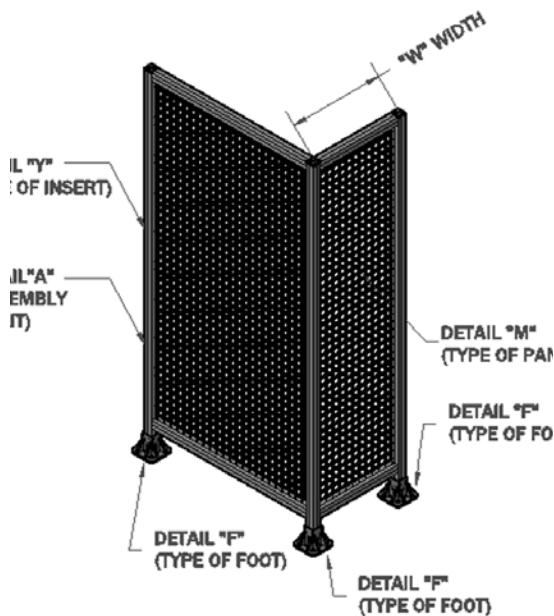
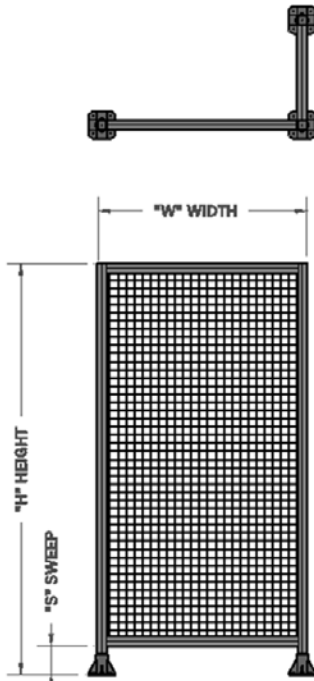

Guard Type (Type)
C1 - Single Leg on Left
C2 - Single Leg on Right
C3 - Legs on Both Sides
C4 - No Legs
C5 - Leg on Left and In Center
C6 - Leg on Right and In Center
C7 - One Leg In Center
C8 - Three Legs
Ref view from outside cell

Height
Height of Guard (MM) Measured from bottom of foot to top of the guard Max panel height - sweep = 2400MM

Width 1
Width of Guard (MM) Measured from outside edge to outside edge Max width is 1200MM

Width 2
Width of Guard (MM) Measured from outside edge to outside edge Max width is 1200MM

Sweep
Sweep of Guard (MM) Measured from bottom of foot to bottom of the guard Sweep = Height - panel height

Connection Non-Foot End (Connection)
T - Tie Plates Top, Angle at Bottom Tie plate good for straight connection
P - Tie Plates Top and Bottom Good for adding a panel to a fence section
A - 45 Degree Angle on Top and Bottom Angle good for 90 degree wall connections
H - Hinge Hinge good for odd angle connection
Z - No Connection Standard on A3

Insert
Y - Yellow Insert
O - Orange Insert
Z - None
Powder coated extrusion available on request

Panel Material (Panel)
M - 1" x 1" Mesh
U - Blue - 1/4" PVC Board
G - Grey - 1/4" PVC Board
B - Black - 1/4" PVC Board
W - White - 1/4" PVC Board
P - 1/4" Polycarbonate
L - Aluminum Composite Paneling
C - 0.090 Aluminum Panel - Not Coated
R - No Panel with Retainer Insert
N - No Mesh with Retainer Insert
Z - No Panel
Other panels, mesh, and colors available upon request

Foot Type (Foot)
F - Four Sided Foot Min sweep >150MM
T - Three Sided Foot Can be adjusted at install
P - 2" Pad and Angle Bar
A - Single Small Angle 45 x 90
Z - No Foot

Assembled or Kit (Assembly)
A - Assembled Factory assemblies
K - Kit Customer assemblies

## Double Wall Corners Guard Types



**C1 - Single Leg on Left**



**C2 - Single Leg on Right**



**C3 - Legs on Both Sides**



**C4 - No Legs**



**C5 - Leg on Left and in Center**



**C6 - Leg on Left and in Center**

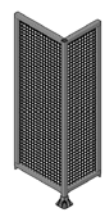

**C7 - One Leg in Center**



**C8 - Three Legs**

## Connection Options

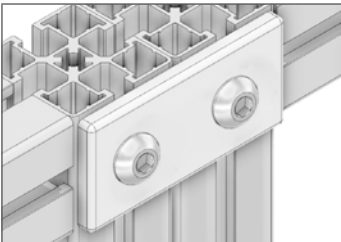

**T, P - Tie Plate**  
45MM x 90MM plate for connecting two pieces of 45MM wide profile together.

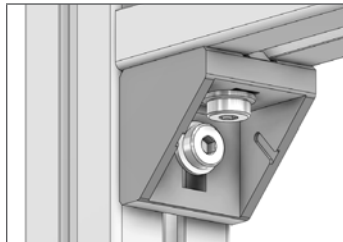

**A - 45 Degree Angle**  
90 degree angle 45MM wide x 45MM deep. Angle bracket used for connecting two pieces of 45MM wide profile together.



**H - Hinge**  
Externally mounted hinge for connecting two wall panels together for 45MM wide profile.

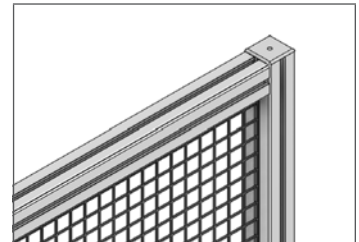

**Z - No Connection**  
No connections on the non-foot end.

## Insert Options

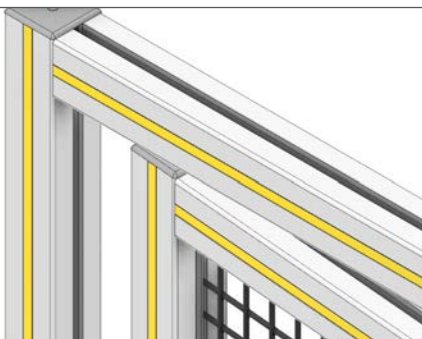

**Y - Yellow Insert**  
Yellow plastic cover will be inserted in the outside T-slot to keep T-slot clear of debris and indicate safety fence zone for many customers standards. Goes in the outside face of the fence's T-slot.

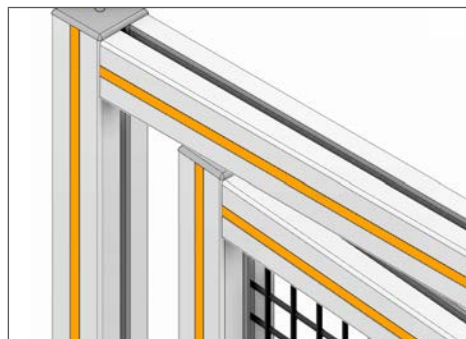

**O - Orange Insert**  
Orange plastic cover will be inserted in the outside T-Slot to keep T-slot clear of debris and indicate a zone. Goes in the outside face of the fence's T-slot.

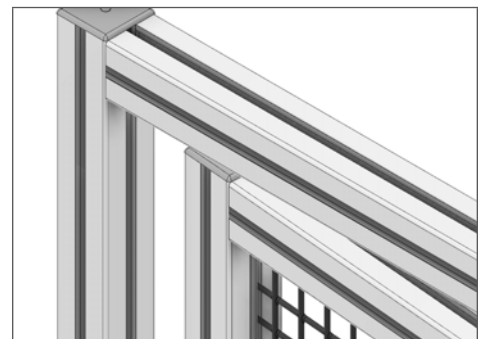

**N - None**  
No plastic cover inserted into the T-slot.

## Panel Material

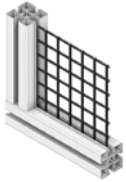

**M - Mesh**  
1" x 1" 12AWG welded wire mesh, with a PVC coating, and a pattern of 1" x 1" on the wire center lines.



**P - Polycarbonate**  
¼" clear paneling made of polycarbonate material.

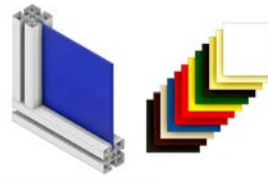

**U, G, B, W - PVC Board**  
PVC foam board compressed for a smooth surface and light weight material. Comes in a large variety of colors. White, blue, black, and gray are our standards, but many others are available.



**L - Aluminum Composite Panel**  
Aluminum board with a painted silver metallic surface and a plastic corrugated core.



**C - Aluminum Panel**  
Solid 0.09" non-anodized aluminum paneling.



**R - No Panel with Retainer Insert**  
This is a plastic insert commonly used to hold ¼" paneling into the T-slot.



**N - No Mesh with Retainer Insert**  
This is a plastic insert commonly used to hold 1" mesh into the T-slot.



**Z - No Panel**

## Foot Types



**F - Four Sided Foot**  
Standard foot with pad and anchor points on all four sides of the post where it touches the ground. 9MM diameter mounting holes.

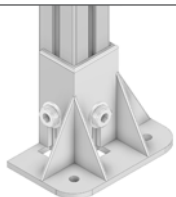

**T - Three Sided Foot**  
Foot with pad and anchor points on three of the four sides of the guard. Comes standard on doors with flush side in the door. Comes standard on guard with flush side on inside of guard. Can easily be field rotated.



**P - 2" Pad and Angel Bar**  
Leveling pad with 2" surface, and angle bar for providing an anchor point.



**A - Single Small Angle**  
90 degree angle, 45MM wide x 90MM long/tall for a single simple anchor point.

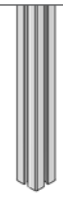

**Z - No Foot**  
Aluminum profile go to the floor. No support or anchor point.

## Assembled or Kit



**A - Assembled**  
We build the fence sections to the print.

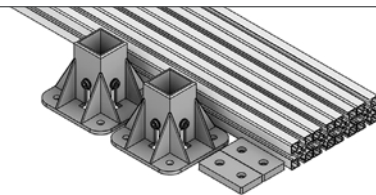

**K - Kit**  
Typically, a lower cost alternative where the customer will assemble the wall section themselves.



## How to Order

<b>D1</b>	<b>-</b>	<b>1000</b>	<b>-</b>	<b>1000</b>	<b>-</b>	<b>1000</b>	<b>-</b>	<b>0150</b>	<b>-</b>	<b>Y</b>	<b>M</b>	<b>F</b>	<b>A</b>
-----------	----------	-------------	----------	-------------	----------	-------------	----------	-------------	----------	----------	----------	----------	----------

Type      Height      Width      Depth      Sweep      Insert      Panel      Foot      Assembly

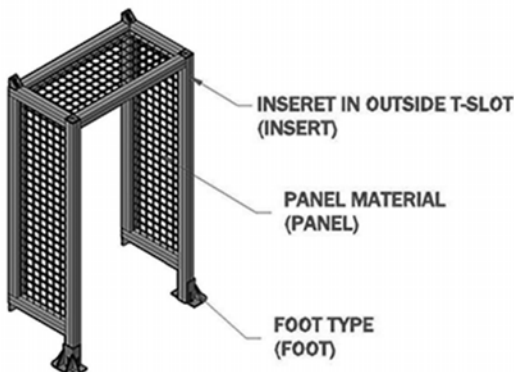
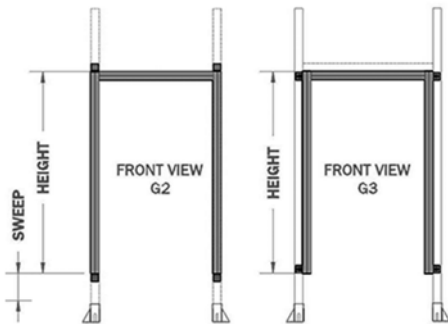
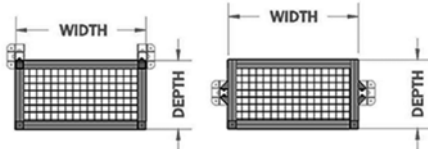
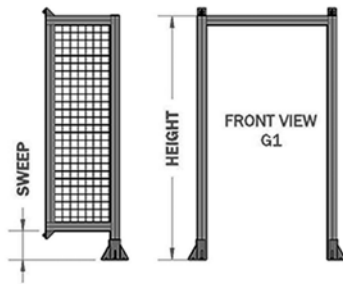
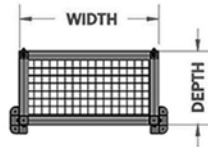

Guard Type (Type)
<b>D1 - Dog House W/ Legs</b> Bolts on posts
<b>D2 - No Legs</b> Bolts on posts
<b>D3 - No Legs</b> Goes inside opening
Ref view from outside cell

Height
<b>Height of Guard (MM)</b> Measured from bottom of foot to top of the guard Max panel height - sweep = 2400MM

Width
<b>Width of Guard (MM)</b> Measure from outside edge to outside edge Max width is 1200MM

Depth
<b>Depth of Guard (MM)</b> Measure from outside edge to outside edge Max width is 1200MM

Sweep
<b>Sweep of Guard (MM)</b> Measured from bottom of foot to bottom of the guard Sweep = Height - panel height

Connection Non-Foot End (Connection)
<b>T - Tie Plates Top, Angle at Bottom</b> Tie plate good for straight connection
<b>P - Tie Plates Top and Bottom</b> Good for adding a panel to a fence section
<b>A - 45 Degree Angle on Top and Bottom</b> Angle good for 90 degree wall connections
<b>H - Hinge</b> Hinge good for odd angle connection
<b>Z - No Connection</b> Standard on A3

Insert
<b>Y - Yellow Insert</b>
<b>O - Orange Insert</b>
<b>Z - None</b>
Powder coated extrusion available on request

Panel Material (Panel)
<b>M - 1" x 1" Mesh</b>
<b>U - Blue - 1/4" PVC Board</b>
<b>G - Grey - 1/4" PVC Board</b>
<b>B - Black - 1/4" PVC Board</b>
<b>W - White - 1/4" PVC Board</b>
<b>P - 1/4" Polycarbonate</b>
<b>L - Aluminum Composite Paneling</b>
<b>C - 0.090 Aluminum Panel - Not Coated</b>
<b>R - No Panel with Retainer Insert</b>
<b>N - No Mesh with Retainer Insert</b>
<b>Z - No Panel</b>
Other panels, mesh, and colors available upon request

Foot Type (Foot)
<b>F - Four Sided Foot</b> Min sweep >150MM
<b>T - Three Sided Foot</b> Can be adjusted at install
<b>P - 2" Pad and Angle Bar</b>
<b>A - Single Small Angle</b> 45 x 90
<b>Z - No Foot</b>

Assembled or Kit (Assembly)
<b>A - Assembled</b> Factory assemblies
<b>K - Kit</b> Customer assemblies

### Dog House Guard Types

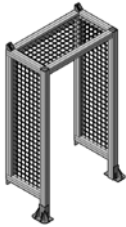

**D1 - Dog House W/ Legs (Bolts on Posts)**



**D2 - No Legs (Bolts on Posts)**



**D3 - No Legs (Goes Inside Opening)**

### Insert Options

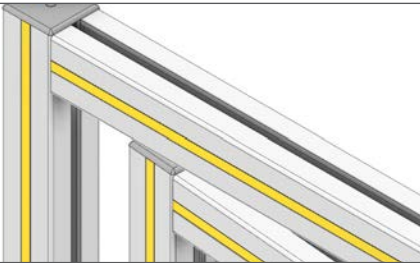

**Y - Yellow Insert**

Yellow plastic cover will be inserted in the outside T-slot to keep T-slot clear of debris and indicate safety fence zone for many customers standards. Goes in the outside face of the fence's T-slot.

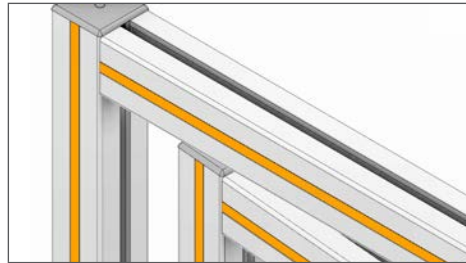

**O - Orange Insert**

Orange plastic cover will be inserted in the outside T-Slot to keep T-slot clear of debris and indicate a zone. Goes in the outside face of the fence's T-slot.

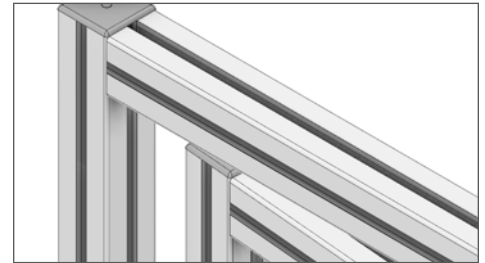

**N - None**

No plastic cover inserted into the T-slot.

### Panel Material



**M - Mesh**

1" x 1" 12AWG welded wire mesh, with a PVC coating, and a pattern of 1" x 1" on the wire center lines.



**P - Polycarbonate**

¼" clear paneling made of polycarbonate material.

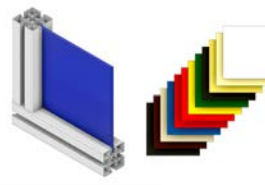

**U, G, B, W - PVC Board**

PVC foam board compressed for a smooth surface and light weight material. Comes in a large variety of colors. White, blue, black, and gray are our standards, but many others are available.



**L - Aluminum Composite Panel**

Aluminum board with a painted silver metallic surface and a plastic corrugated core.



**C - Aluminum Panel**

Solid 0.09" non-anodized aluminum paneling.



**R - No Panel with Retainer Insert**

This is a plastic insert commonly used to hold ¼" paneling into the T-slot.



**N - No Mesh with Retainer Insert**

This is a plastic insert commonly used to hold 1" mesh into the T-slot.



**Z - No Panel**

## Foot Types



### F - Four Sided Foot

Standard foot with pad and anchor points on all four sides of the post where it touches the ground. 9MM diameter mounting holes.

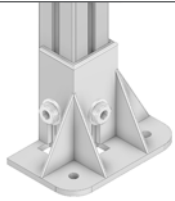

### T - Three Sided Foot

Foot with pad and anchor points on three of the four sides of the guard. Comes standard on doors with flush side in the door. Comes standard on guard with flush side on inside of guard. Can easily be field rotated.



### P - 2" Pad and Angel Bar

Leveling pad with 2" surface, and angle bar for providing an anchor point.



### A - Single Small Angle

90 degree angle, 45MM wide x 90MM long/tall for a single simple anchor point.



### Z - No Foot

Aluminum profile go to the floor. No support or anchor point.

## Assembled or Kit

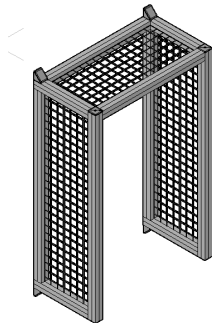

### A - Assembled

We build the fence sections to the print.

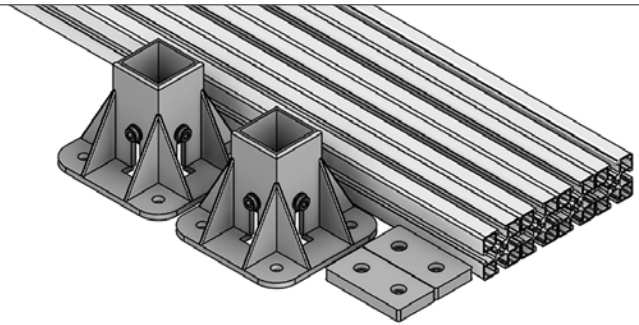

### K - Kit

Typically, a lower cost alternative where the customer will assemble the wall section themselves.

## What is a Dog House?

Dog houses are types of safety guarding typically used where equipment such as a conveyor enters into openings in a fence. They prevent people from reaching dangerous spots which the surrounding fence would not block.

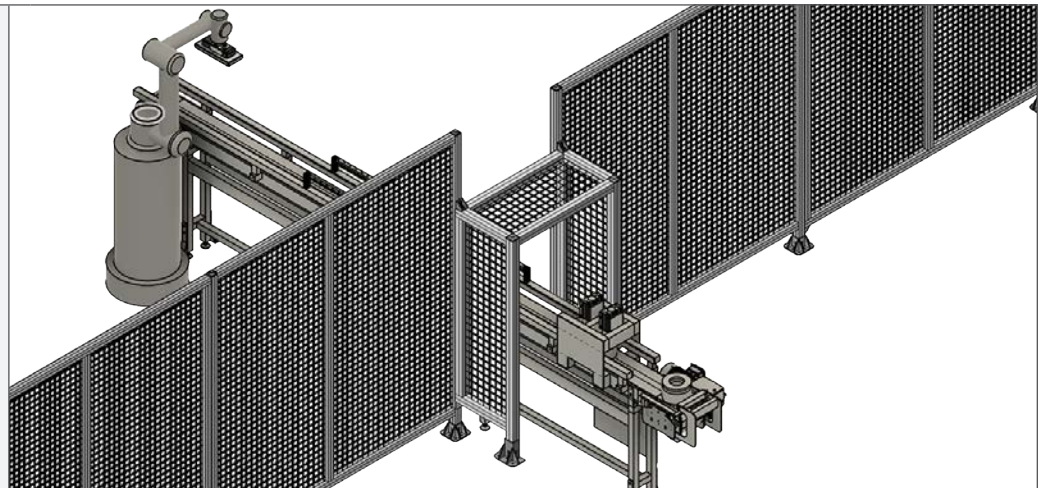

## How to Order

<b>E1</b>	-	<b>1000</b>	-	<b>1000</b>	-	<b>0150</b>	-	<b>G</b>	<b>Y</b>	<b>M</b>	<b>T</b>	<b>A</b>
Type		Height		Width		Sweep		Connection	Insert	Panel	Foot	Assembly

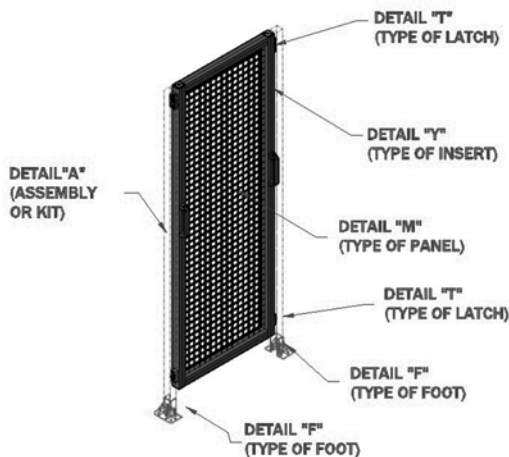
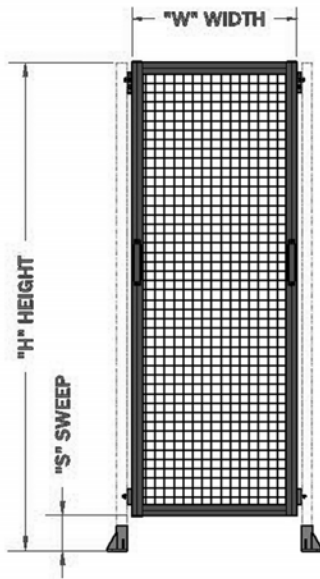

Guard Type (Type)
E1 - Single Panel
E2 - Double Panel
E3 - Single Panel W/ Legs
E4 - Double Panel W/ Legs
E5 - Single Panel W/ Legs and Header
E6 - Double Panel W/ Legs and Header

Height
Height of Guard (MM) Measured from bottom of foot to top of the guard Max panel height = 2400MM

Width
Width of Guard (MM) Measure from outside edge to outside edge Max width is 1200MM (Single), 2400MM (Double)

Sweep
Sweep of Guard (MM) Measured from bottom of foot to bottom of the guard Sweep = Height - panel height

Securing System (Connection)
L - Pivot Bottom, Locking System
G - Pivot Bottom, Angle on Top
S - Pivot Bottom, Angle on Top W/ Key

Insert
Y - Yellow Insert
O - Orange Insert
J - Orange Insert on Inside, Yellow on Outside
Q - Yellow Insert on Inside, Orange on Outside
Z - None
Powder coated extrusion available on request

Panel Material (Panel)
M - 1" x 1" Mesh
U - Blue - 1/4" PVC Board
G - Grey - 1/4" PVC Board
B - Black - 1/4" PVC Board
W - White - 1/4" PVC Board
P - 1/4" Polycarbonate
L - Aluminum Composite Paneling
C - 0.090 Aluminum Panel - Not Coated
R - No Panel with Retainer Insert
N - No Mesh with Retainer Insert
Z - No Panel
Other panels, mesh, and colors available upon request

Foot Type (Foot)
T - Three Sided Foot Can be adjusted at install
P - 2" Pad and Angle Bar
A - Single Small Angle 45 x 90
Z - No Foot

Assembled or Kit (Assembly)
A - Assembled Factory assemblies
K - Kit Customer assemblies

## Removable Panels Guard Types

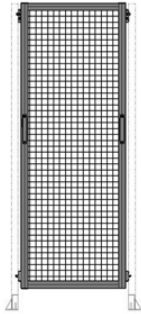

**E1 - Single Panel**

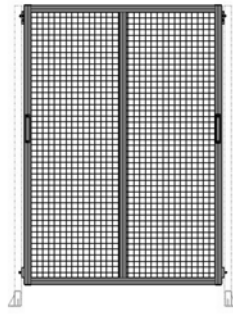

**E2 - Double Panel**

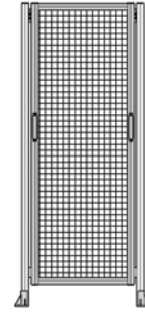

**E3 - Single Panel W/ Legs**

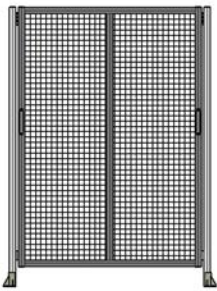

**E4 - Double Panel W/ Legs**

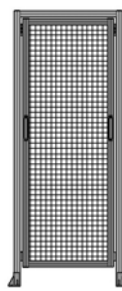

**E5 - Single Panel W/ Legs and Header**

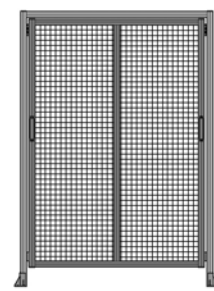

**E6 - Double Panel W/ Legs and Header**

## Security System (Connection)

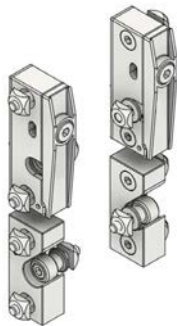

**L - Pivot Bottom Locking System**

This is a patent pending unique locking system for removable panels. 1/4 turn lock, and pivot at the bottom to hold guard while putting into place.

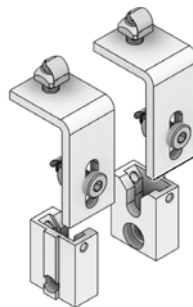

**G - Pivot Bottom, Angle on Top**

"L" bracket on top to attach panel to horizontal supporting extrusion. Common pivot at the bottom to hold guard while putting into place.



**H - Hinge**

Externally mounted hinge for connecting two wall panels together for 45MM wide profile.

## Insert Options

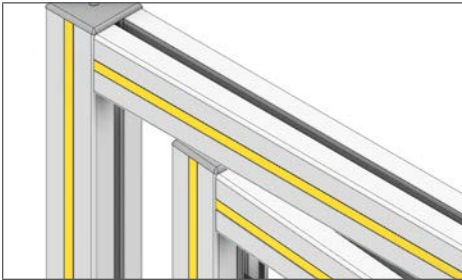

**Y - Yellow Insert**



**O - Orange Insert**

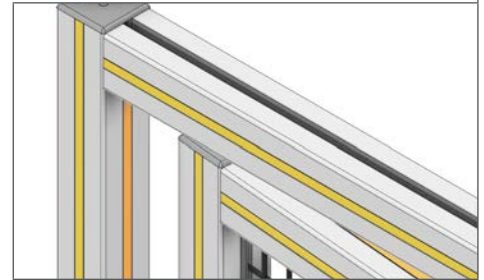

**J - Orange Insert on Inside, Yellow on Outside**

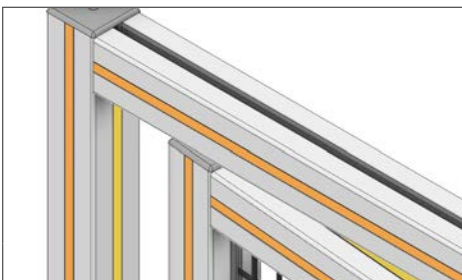

**Q - Yellow Insert on Inside, Orange on Outside**

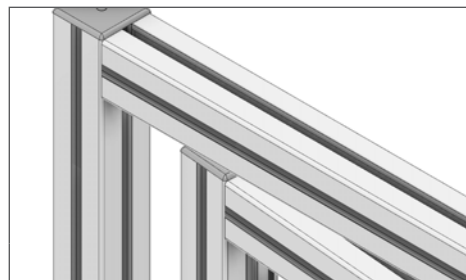

**Z - None**



**Powder Coating Available.  
Contact Us for More Information**

## Panel Material

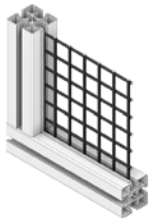

**M - Mesh**

1" x 1" 12AWG welded wire mesh, with a PVC coating, and a pattern of 1" x 1" on the wire center lines.



**P - Polycarbonate**

¼" clear paneling made of polycarbonate material.

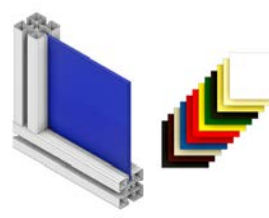

**U, G, B, W - PVC Board**

PVC foam board compressed for a smooth surface and light weight material. Comes in a large variety of colors. White, blue, black, and gray are our standards, but many others are available.



**L - Aluminum Composite Panel**

Aluminum board with a painted silver metallic surface and a plastic corrugated core.



**C - Aluminum Panel**

Solid 0.09" non-anodized aluminum paneling.



**R - No Panel with Retainer Insert**

This is a plastic insert commonly used to hold ¼" paneling into the T-slot.



**N - No Mesh with Retainer Insert**

This is a plastic insert commonly used to hold 1" mesh into the T-slot.



**Z - No Panel**

## Foot Types

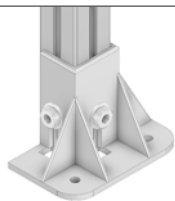

### T - Three Sided Foot

Foot with pad and anchor points on three of the four sides of the guard. Comes standard on doors with flush side in the door. Comes standard on guard with flush side on inside of guard. Can easily be field rotated.



### P - 2" Pad and Angel Bar

Leveling pad with 2" surface, and angle bar for providing an anchor point.



### A - Single Small Angle

90 degree angle, 45MM Wide x 90MM long/tall for a single simple anchor point.



### Z - No Foot

Aluminum profile go to the floor - No support or anchor point.

## Assembled or Kit

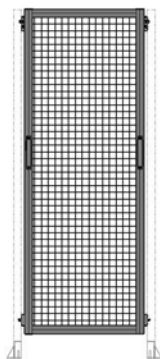

### A - Assembled

We build the fence sections to the print.

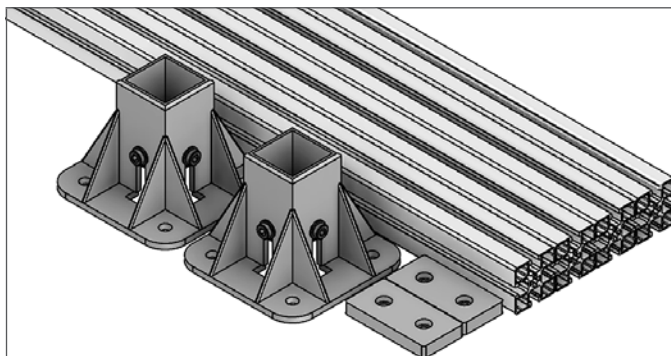

### K - Kit

Typically, a lower cost alternative where the customer will assemble the wall section themselves.

## Why a Removable Panel?

Removable panels allow for access to a cell without a door or disassembling the guard. They typically cost less than a door are not as ideal for frequent entries.

Scan this QR code to check out this video that demonstrates the G - Pivot Bottom, Angle on Top type connection.

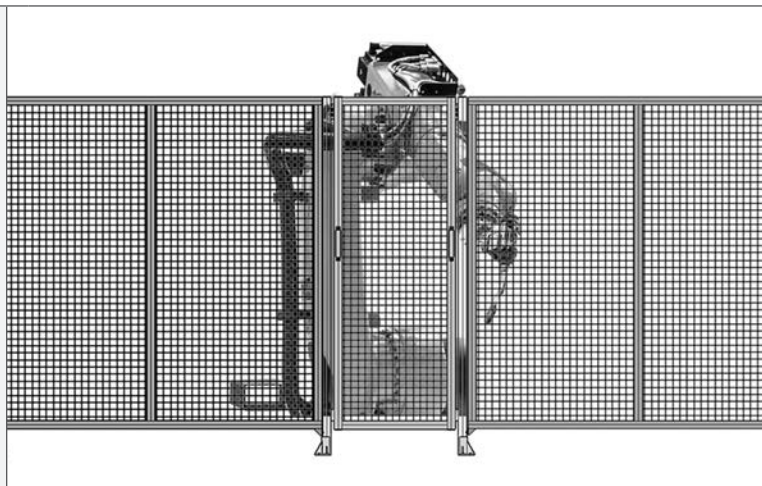

**How to Order**

<b>F1</b>	<b>-</b>	<b>1000</b>	<b>-</b>	<b>1000</b>	<b>-</b>	<b>H</b>	<b>-</b>	<b>T</b>	<b>Y</b>	<b>M</b>	<b>A</b>
-----------	----------	-------------	----------	-------------	----------	----------	----------	----------	----------	----------	----------

Type      Height      Width      Open Side      Non-Open Side      Insert      Panel      Assembly

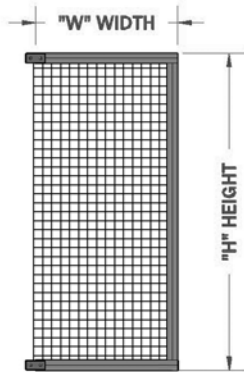

**VIEWS FOR F1-F4**

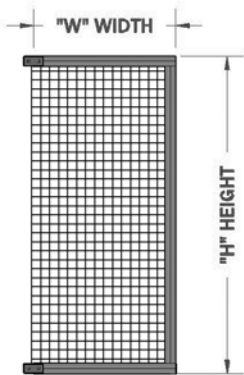
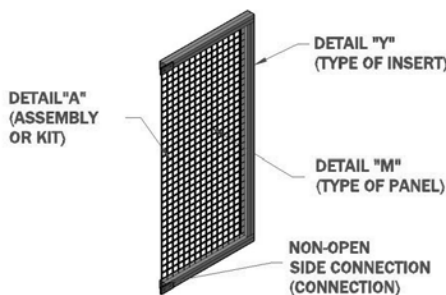

**VIEW FOR F5-F8**

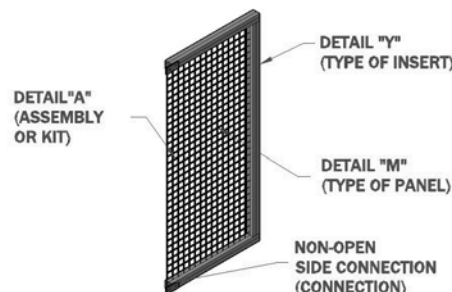

Guard Type (Type)
F1 - Opening on Left
F2 - Opening on Right
F3 - Opening on Top
F4 - Opening on Bottom
F5 - Opening on Top and Left
F6 - Opening on Top and Right
F7 - Opening on Bottom and Left
F8 - Opening on Bottom and Right

Height
Height of Guard (MM) Measured from bottom of foot to top of the guard Max panel height = 2400MM

Width
Width of Guard (MM) Measure from outside edge to outside edge Max width is 1200MM (Single), 2400MM (Double)

Opening Side Connections
H - Hidden Profile Fastener
T - Tie Plates (2) Only option for F5-F8

Non-Opening Side Connections
T - Tie Plates (2)
A - Angles (2)
B - Tie Plate (1) and Angle (1)
S - Tie Plate (1) Option for F5-F8
C - Angle (1) Option for F5-F8
Z - Nothing

Insert
Y - Yellow Insert
O - Orange Insert
J - Orange Insert on Inside, Yellow on Outside
Q - Yellow Insert on Inside, Orange on Outside
Z - None
Powder coated extrusion available on request

Panel Material (Panel)
M - 1" x 1" Mesh
U - Blue - 1/4" PVC Board
G - Grey - 1/4" PVC Board
B - Black - 1/4" PVC Board
W - White - 1/4" PVC Board
P - 1/4" Polycarbonate
L - Aluminum Composite Paneling
C - 0.090 Aluminum Panel - Not Coated
R - No Panel with Retainer Insert
N - No Mesh with Retainer Insert
Z - No Panel
Other panels, mesh, and colors available upon request

Assembled or Kit (Assembly)
A - Assembled Factory assemblies
K - Kit Customer assemblies



**Wings Guard Types**

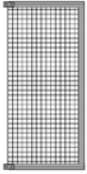

**F1 - Opening on Left**

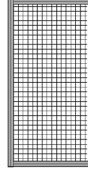

**F2 - Opening on Right**

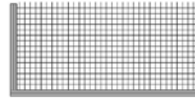

**F3 - Opening on Top**

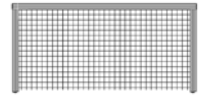

**F4 - Opening on Bottom**

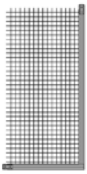

**F5 - Opening on Top and Left**

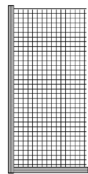

**F6 - Opening on Top and Right**

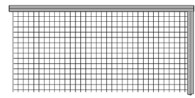

**F7 - Opening on Bottom and Left**

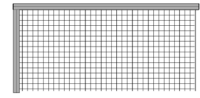

**F8 - Opening on Bottom and Right**

**Opening Side Connection Options**

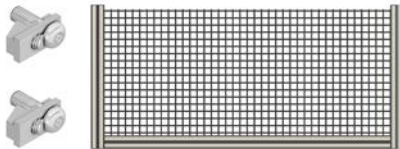

**H - Hidden Profile Fastener**

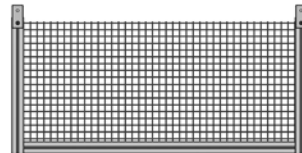

**T - Tie Plates (2)  
Only Option for F5-F8**

**Non-Opening Side Connection Options**

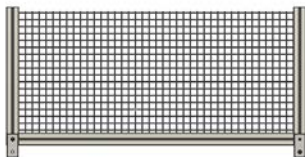

**T - Tie Plates (2)**

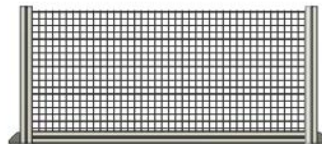

**A - Angles (2)**

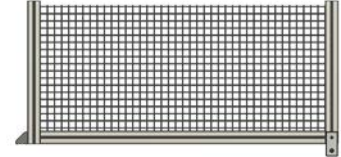

**B - Tie Plate (1) and Angle (1)**

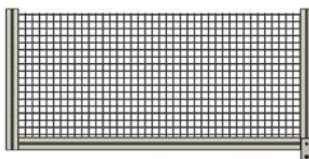

**S - Tie Plate (1)  
Option for F5-F8**

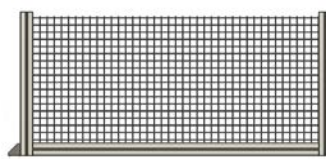

**C - Angle (1)  
Option for F5-F8**

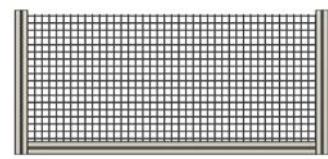

**Z - Nothing**

**Insert Options**

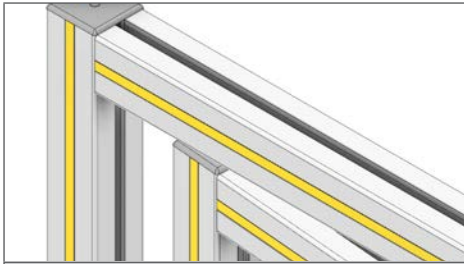

**Y - Yellow Insert**

Yellow plastic cover will be inserted in the outside T-slot to keep T-slot clear of debris and indicate safety fence zone for many customers standards. Goes in the outside face of the fence's T-slot.

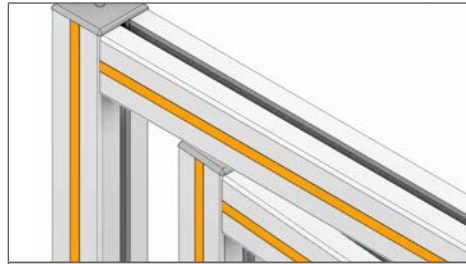

**O - Orange Insert**

Orange plastic cover will be inserted in the outside T-Slot to keep T-slot clear of debris and indicate a zone. Goes in the outside face of the fence's T-slot.

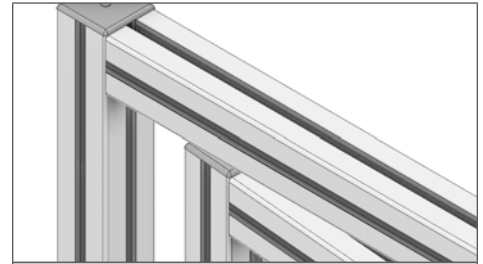

**N - None**

No plastic cover inserted into the T-slot.

**Panel Material**



**M - Mesh**

1" x 1" 12AWG welded wire mesh, with a PVC coating, and a pattern of 1" x 1" on the wire center lines.



**P - Polycarbonate**

¼" clear paneling made of polycarbonate material.

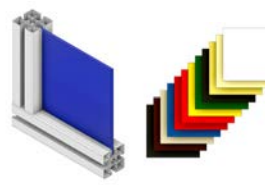

**U, G, B, W - PVC Board**

PVC foam board compressed for a smooth surface and light weight material. Comes in a large variety of colors. White, blue, black, and gray are our standards, but many others are available.



**L - Aluminum Composite Panel**

Aluminum board with a painted silver metallic surface and a plastic corrugated core.



**C - Aluminum Panel**

Solid 0.09" non-anodized aluminum paneling.



**R - No Panel with Retainer Insert**

This is a plastic insert commonly used to hold ¼" paneling into the T-slot.



**N - No Mesh with Retainer Insert**

This is a plastic insert commonly used to hold 1" mesh into the T-slot.



**Z - No Panel**

**Assembled or Kit**

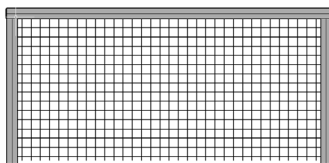

**A - Assembled**

We build the fence sections to the print.

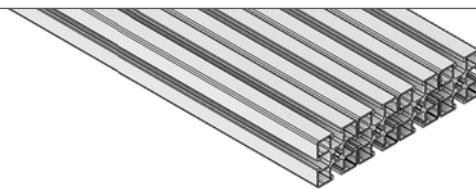

**K - Kit**

Typically, a lower cost alternative where the customer will assemble the wall section themselves.

## How to Order

<b>G1</b>	<b>-</b>	<b>1000</b>	<b>-</b>	<b>1000</b>	<b>-</b>	<b>0150</b>	<b>-</b>	<b>T</b>	<b>Y</b>	<b>M</b>	<b>F</b>	<b>T</b>
Type		Height		Width		Sweep		Handle	Insert	Panel	Foot	Assembly

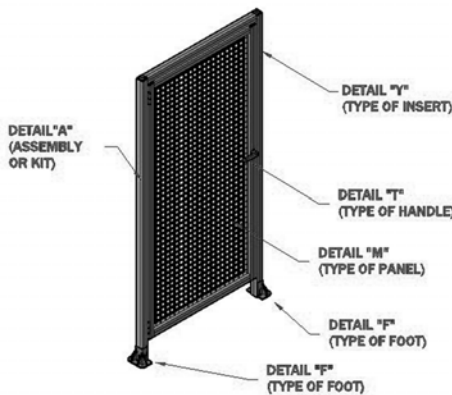
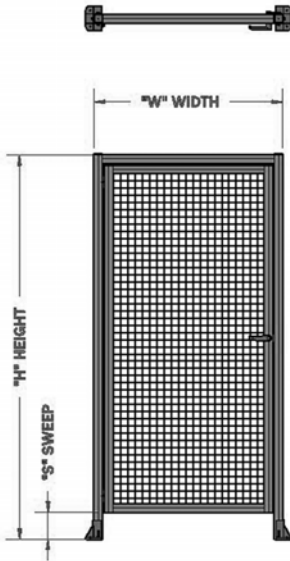

Guard Type (Type)
G1 - Hinge on Left W/ Header
G2 - Hinge on Right W/ Header
G3 - Hinge on Left - No Frame or Header
G4 - Hinge on Right - No Frame or Header
G5 - Hinge on Left - Robust Frame, W/O Header
G6 - Hinge on Right - Robust Frame, W/O Header

Insert
Y - Yellow Insert
O - Orange Insert
J - Orange Insert on Inside, Yellow on Outside
Q - Yellow Insert on Inside, Orange on Outside
Z - None
Powder coated extrusion available on request

Height
Height of Door Section (MM) Measured from bottom of foot to top of the guard Max door panel height = 2400MM

Panel Material (Panel)
M - 1" x 1" Mesh
U - Blue - 1/4" PVC Board
G - Grey - 1/4" PVC Board
B - Black - 1/4" PVC Board
W - White - 1/4" PVC Board
P - 1/4" Polycarbonate
L - Aluminum Composite Paneling
C - 0.090 Aluminum Panel - Not Coated
R - No Panel with Retainer Insert
N - No Mesh with Retainer Insert
Z - No Panel
Other panels, mesh, and colors available upon request

Width
Width of Door Assembly (MM) Measure from outside edge to outside edge Max width is 1200MM (Single), 1200MM

Sweep
Sweep of Door Assembly (MM) Measured from bottom of foot to bottom of the guard Sweep = Height - panel height

Handle Options (Handle)
T - Turn Handle and Stop
L - Locking Turn Handle and Stop
P - Pull Handle W/ Catch
X - No Pull Handle W/ Catch
E - Turn Handle W/ Internal Egress
S - Just Rubber Stop at Top - No Handles
Z - No Handles, Stops or Catches

Foot Type (Foot)
T - Three Sided Foot Can be adjusted at install
P - Two Inch Pad and Angle Bar
Z - No Foot

Assembled or Kit (Assembly)
A - Assembled Factory assemblies
K - Kit Customer assemblies

## Single Swing Door Guard Types

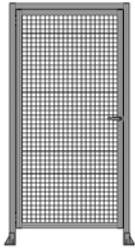

**G1 - Hinge on Left W/ Header**

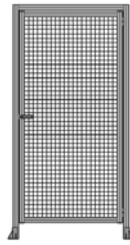

**G2 - Hinge on Right W/ Header**

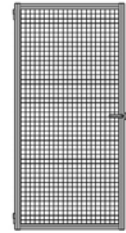

**G3 - Hinge on Left - No Frame or Header**

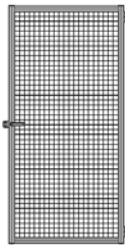

**G4 - Hinge on Right - No Frame or Header**

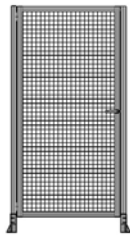

**G5 - Hinge on Left - Robust Frame, W/O Header**

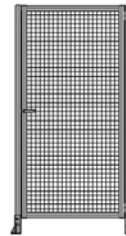

**G6 - Hinge on Right - Robust Frame, W/O Header**

## Handle Options (Handle)



**T - Turn Handle and Stop**

Quarter turn handle with a cam that goes through the door post like a traditional door handle. On the opposite end is a cam that engages with door stop



**L - Locking Turn Handle and Stop**

Locking Turn Handle same as the ¼ turn "T", but with a Key lock.

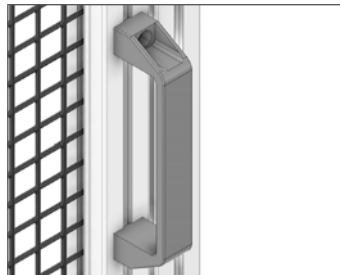

**P - Pull Handle W/ Catch**

Pull Handle with Catch has a 180mm D handle with a ball latch detent to fold door in place.



**X - No Pull Handle W/ Catch**

Door is opened/closed by pulling/pushing on frame. Door catch holds the door in closed position.

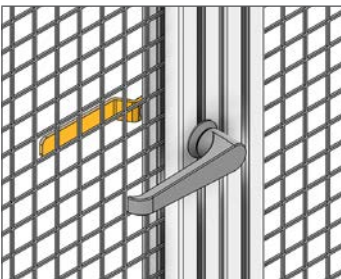

**E - Turn Handle W/ Internal Egress**

Quarter turn handle with a cam that goes through the door post like a traditional door handle. On the opposite end is an egress handle that engages with a door stop

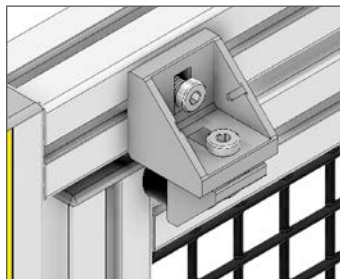

**S - Just Rubber Stop at Top - No Handles**

Rubber stop attaches on inside of guard to stop the door in centered position when pushed closed.

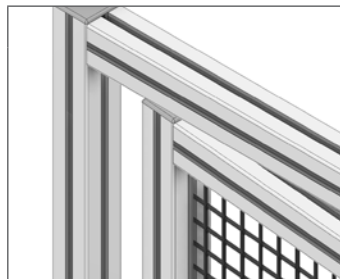

**Z - No Handles, Stops or Catches**

**Other Handles Available**



Contact Us for More Info

## Insert Options

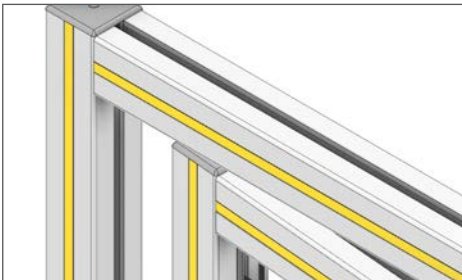

**Y - Yellow Insert**



**O - Orange Insert**

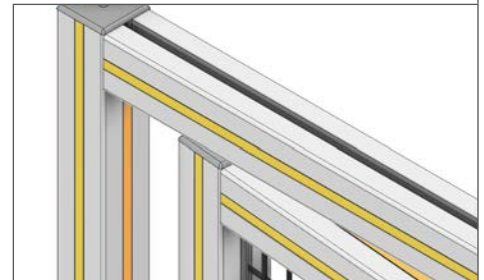

**J - Orange Insert on Inside, Yellow on Outside**

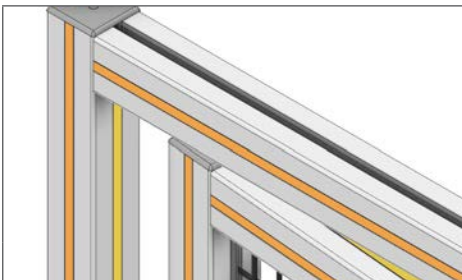

**Q - Yellow Insert on Inside, Orange on Outside**

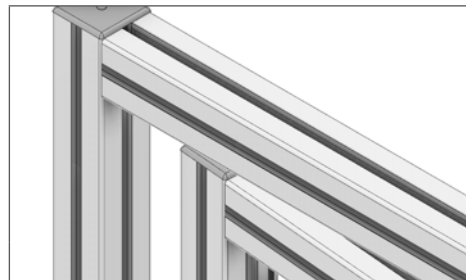

**Z - None**



**Powder Coating Available.  
Contact Us for More Information**

## Panel Material



**M - Mesh**

1" x 1" 12AWG welded wire mesh, with a PVC coating, and a pattern of 1" x 1" on the wire center lines.



**P - Polycarbonate**

¼" clear paneling made of polycarbonate material.

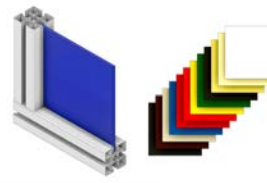

**U, G, B, W - PVC Board**

PVC foam board compressed for a smooth surface and light weight material. Comes in a large variety of colors. White, blue, black, and gray are our standards, but many others are available.



**L - Aluminum Composite Panel**

Aluminum board with a painted silver metallic surface and a plastic corrugated core.



**C - Aluminum Panel**

Solid 0.09" non-anodized aluminum paneling.



**R - No Panel with Retainer Insert**

This is a plastic insert commonly used to hold ¼" paneling into the T-slot.



**N - No Mesh with Retainer Insert**

This is a plastic insert commonly used to hold 1" mesh into the T-slot.



**Z - No Panel**

## Foot Types

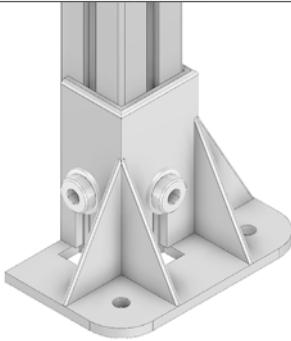

**T - Three Sided Foot**

Foot with pad and anchor points on three of the four sides of the guard. Comes standard on doors with flush side in the door. Comes standard on guard with flush side on inside of guard. Can easily be field rotated.



**P - 2" Pad and Angel Bar**

Leveling pad with 2" surface, and angle bar for providing an anchor point.

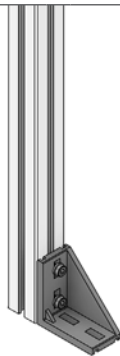

**A - Single Small Angle**

90 degree angle, 45MM wide x 90MM long/tall for a single simple anchor point.

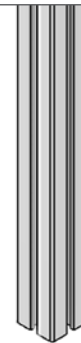

**Z - No Foot**

Aluminum profile go to the floor. No support or anchor point.

## Assembled or Kit

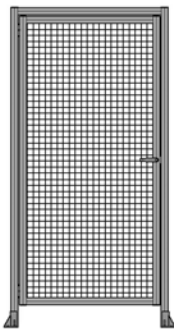

**A - Assembled**

We build the fence sections to the print.

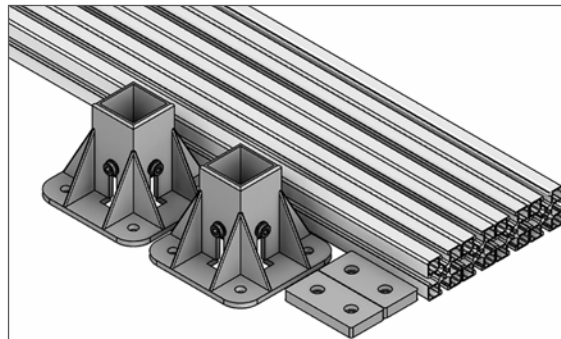

**K - Kit**

Typically, a lower cost alternative where the customer will assemble the wall section themselves.

## How to Order

<b>H1</b>	<b>-</b>	<b>1000</b>	<b>-</b>	<b>1000</b>	<b>-</b>	<b>0150</b>	<b>-</b>	<b>T</b>	<b>Y</b>	<b>M</b>	<b>F</b>	<b>T</b>
Type		Height		Width		Sweep		Handle	Insert	Panel	Foot	Assembly

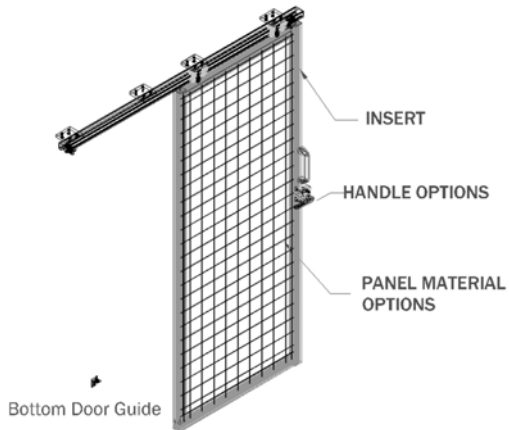

Rail Length = 2 (WIDTH+50mm) - 150MM

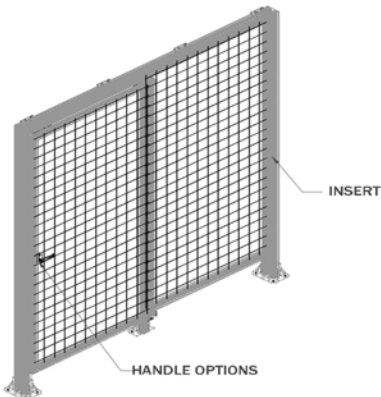
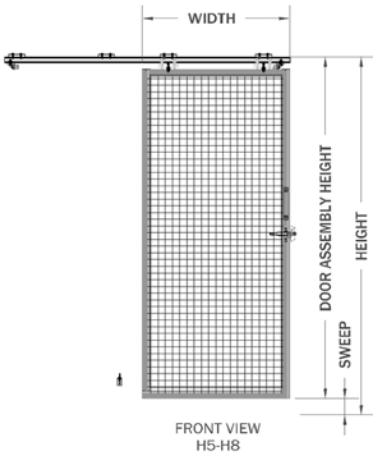

Guard Type (Type)
H1 - Single Panel - Slides Left
H2 - Single Panel - Slides Right
H3 - Double Panel - Slides Left
H4 - Double Panel - Slides Right
H5 - Single Panel W/O Legs - Slides Left
H6 - Single Panel W/O Legs - Slides Right
H7 - Double Panel W/O Legs - Slides Left
H8 - Double Panel W/O Legs - Slides Right

Height
<b>Height of Door Assembly (MM)</b> Measured from bottom of foot to top of the guard Max door panel height = 2400MM

Width
<b>Width of Door Assembly (MM)</b> Measure from outside edge to outside edge Max width is 1200MM (Single), 1200MM

Sweep
<b>Sweep of Door Assembly (MM)</b> Measured from bottom of foot to bottom of the guard Sweep = Height - panel height

Handle Options (Handle)
D - Handles W/ Ball Catch
L - Slide Door Latching Handle W/ Lock
X - No Pull Handle W/ Catch
Z - None

Insert
Y - Yellow Insert
O - Orange Insert
J - Orange Insert on Inside, Yellow on Outside
Q - Yellow Insert on Inside, Orange on Outside
Z - None
Powder coated extrusion available on request

Panel Material (Panel)
M - 1" x 1" Mesh
U - Blue - 1/4" PVC Board
G - Grey - 1/4" PVC Board
B - Black - 1/4" PVC Board
W - White - 1/4" PVC Board
P - 1/4" Polycarbonate
L - Aluminum Composite Paneling
C - 0.090 Aluminum Panel - Not Coated
R - No Panel with Retainer Insert
N - No Mesh with Retainer Insert
Z - No Panel
Other panels, mesh, and colors available upon request

Foot Type (Foot)
T - Three Sided Foot Can be adjusted at install
Z - No Foot

Assembled or Kit (Assembly)
A - Assembled Factory assemblies
K - Kit Customer assemblies

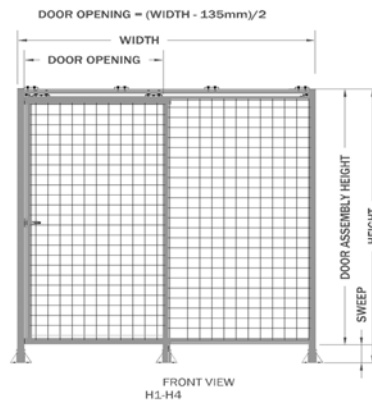

## Sliding Door Guard Types

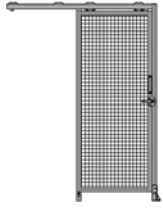

H1 - Single Panel - Slides Left

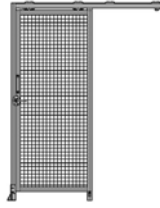

H2 - Single Panel - Slides Right

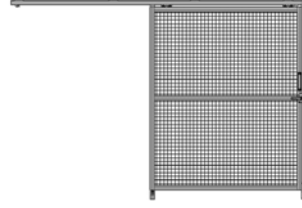

H3 - Double Panel - Slides Left

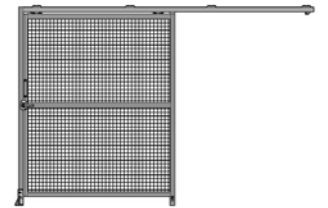

H4 - Double Panel - Slides Right

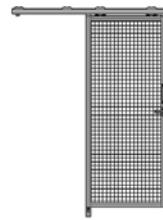

H5 - Single Panel W/O Legs - Slides Left

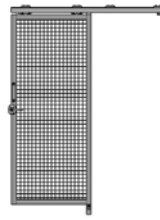

H6 - Single Panel W/O Legs - Slides Right

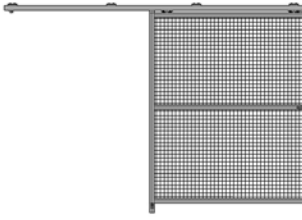

H7 - Double Panel W/O Legs - Slides Left

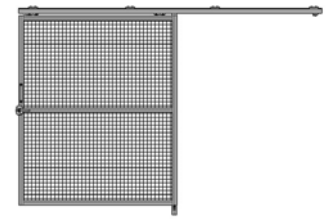

H8 - Double Panel W/O Legs - Slides Right

Quarter turn handle with a cam that goes through the door post like a traditional door handle. On the opposite end is an egress handle that engages with a door stop

## Handle Options (Handle)



### T - Turn Handle and Stop

Quarter turn handle with a cam that goes through the door post like a traditional door handle. On the opposite end is a cam that engages with a door stop



### L - Locking Turn Handle and Stop

Locking Turn Handle same as the ¼ turn "T", but with a Key lock.

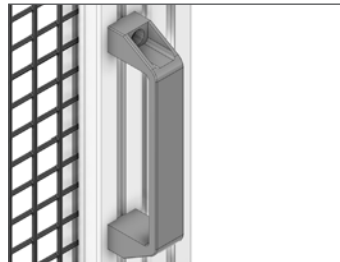

### P - Pull Handle W/ Catch

Pull Handle with Catch has a 180MM D handle with a ball latch detent to fold door in place.



### X - No Pull Handle W/ Catch

Door is opened/closed by pulling/pushing on frame. Door catch holds the door in closed position.

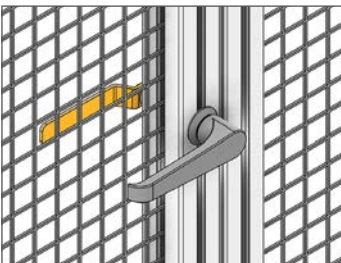

### E - Turn Handle W/ Internal Egress

Quarter turn handle with a cam that goes through the door post like a traditional door handle. On the opposite end is an egress handle that engages with a door stop

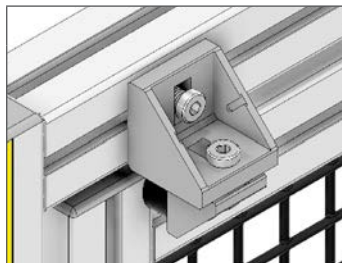

### S - Just Rubber Stop at Top - No Handles

Rubber stop attaches on inside of guard to stop the door in centered position when pushed closed.

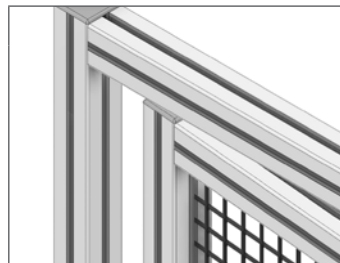

### Z - No Handles, Stops or Catches

## Other Handles Available



Contact Us for More Info



## Insert Options

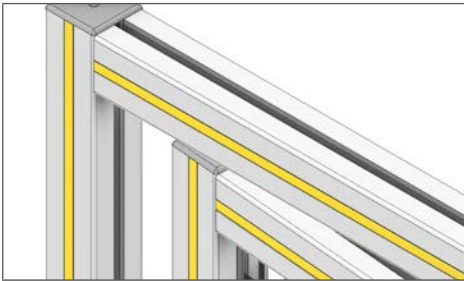

**Y - Yellow Insert**



**O - Orange Insert**

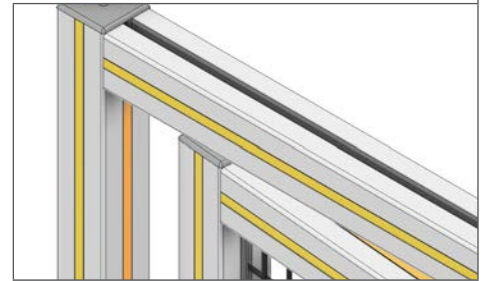

**J - Orange Insert on Inside, Yellow on Outside**

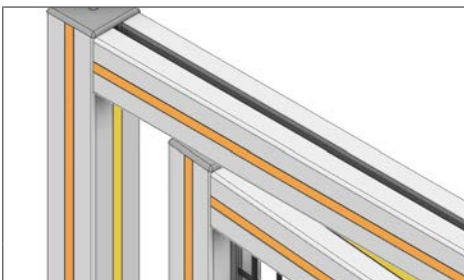

**Q - Yellow Insert on Inside, Orange on Outside**

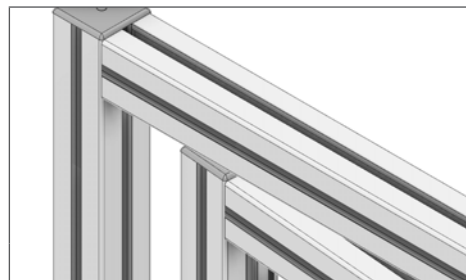

**Z - None**



**Powder Coating Available.  
Contact Us for More Information**

## Panel Material

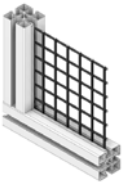

**M - Mesh**

1" x 1" 12AWG welded wire mesh, with a PVC coating, and a pattern of 1" x 1" on the wire center lines.



**P - Polycarbonate**

¼" clear paneling made of polycarbonate material.

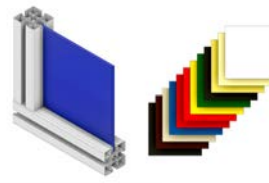

**U, G, B, W - PVC Board**

PVC foam board compressed for a smooth surface and light weight material. Comes in a large variety of colors. White, blue, black, and gray are our standards, but many others are available.



**L - Aluminum Composite Panel**

Aluminum board with a painted silver metallic surface and a plastic corrugated core.



**C - Aluminum Panel**

Solid 0.09" non-anodized aluminum paneling.



**R - No Panel with Retainer Insert**

This is a plastic insert commonly used to hold ¼" paneling into the T-slot.



**N - No Mesh with Retainer Insert**

This is a plastic insert commonly used to hold 1" mesh into the T-slot.



**Z - No Panel**

## Foot Types

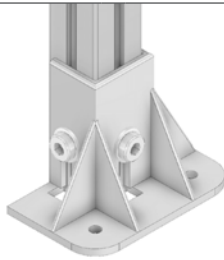

### T - Three Sided Foot

Foot with pad and anchor points on three of the four sides of the guard. Comes standard on doors with flush side in the door. Comes standard on guard with flush side on inside of guard. Can easily be field rotated.



### Z - No Foot

Aluminum profile go to the floor - No support or anchor point.

## Assembled or Kit

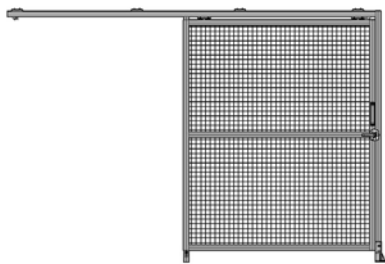

### A - Assembled

We build the fence sections to the print.

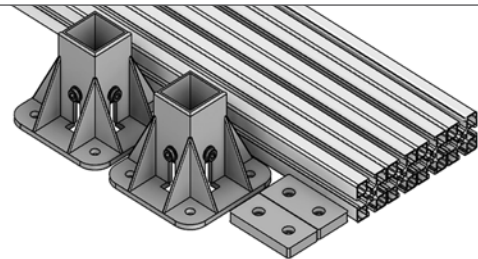

### K - Kit

Typically, a lower cost alternative where the customer will assemble the wall section themselves.

## Why a Sliding Door?

Sliding doors are nice because they don't require the space needed to swing open like with a hinged style door. This can be a big benefit for places close to busy walkways or places with limited quarters. They especially comes into play when using a wide door. Since sliding doors tuck away they create an easier to maneuver work area and reduce the risk of injury to employees.

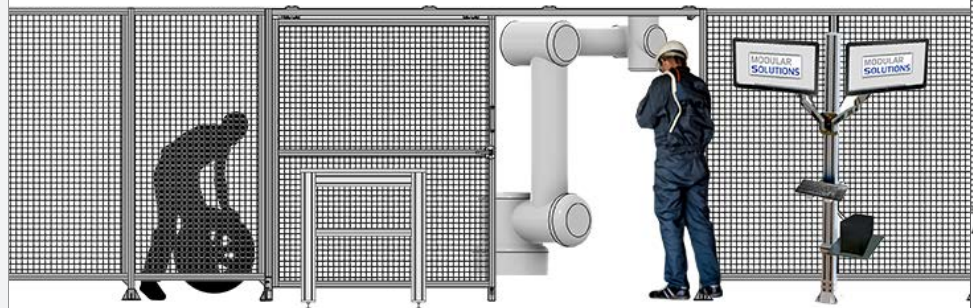

## How to Order

<b>J1</b>	<b>-</b>	<b>1000</b>	<b>-</b>	<b>1000</b>	<b>-</b>	<b>0150</b>	<b>-</b>	<b>T</b>	<b>Y</b>	<b>M</b>	<b>F</b>	<b>T</b>
-----------	----------	-------------	----------	-------------	----------	-------------	----------	----------	----------	----------	----------	----------

Type      Height      Width      Sweep      Handle      Insert      Panel      Foot      Assembly

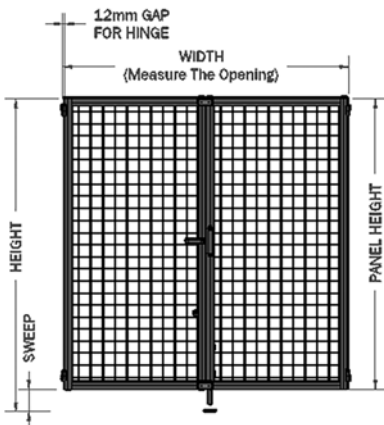
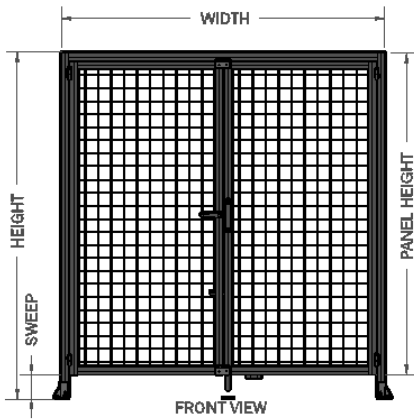
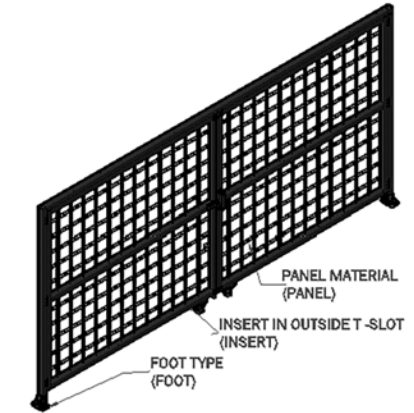

Guard Type (Type)
J1 - Single Panel Doors W/ Header
J2 - Single Panel Doors - No Frame or Header
J3 - Single Panel Doors - Robust Frame W/ Header
J4 - Single Panel Doors - Robust Frame W/O Header
J5 - Double Panel Doors W/ Header
J6 - Double Panel Doors - No Frame or Header
J7 - Double Panel Doors - Robust Frame W/ Header
J8 - Double Panel Doors - Robust Frame W/O Header
All panels with cane bolt on right. Double panels come with two casters.

Height
<b>Height of Door Assembly (MM)</b> Measured from bottom of foot to top of the guard Max door panel height = 2400MM

Width
<b>Width of Door Assembly (MM)</b> Measure from outside edge to outside edge Max width is 1200MM (Single), 1200MM

Sweep
<b>Sweep of Door Assembly (MM)</b> Measured from bottom of foot to bottom of the guard Sweep = Height - panel height

Handle Options (Handle)
T - Turn Handle and Stop
L - Locking Turn Handle and Stop
D - D Hand W/ Ball Catch on Top (J1, J3, J5, J7 Only)
B - No Handle W/ Ball Catch on Top (J1, J3, J5, J7 Only)
Z - No Handle

Insert
Y - Yellow Insert
O - Orange Insert
J - Orange Insert on Inside, Yellow on Outside
Q - Yellow Insert on Inside, Orange on Outside
Z - None
Powder coated extrusion available on request

Panel Material (Panel)
M - 1" x 1" Mesh
U - Blue - 1/4" PVC Board
G - Grey - 1/4" PVC Board
B - Black - 1/4" PVC Board
W - White - 1/4" PVC Board
P - 1/4" Polycarbonate
L - Aluminum Composite Paneling
C - 0.090 Aluminum Panel - Not Coated
R - No Panel with Retainer Insert
N - No Mesh with Retainer Insert
Z - No Panel
Other panels, mesh, and colors available upon request

Foot Type (Foot)
T - Three Sided Foot Can be adjusted at install
Z - No Foot

Assembled or Kit (Assembly)
A - Assembled Factory assemblies
K - Kit Customer assembles

## Double Swing Door Guard Types



**J1 - Single Panel Doors W/ Header**

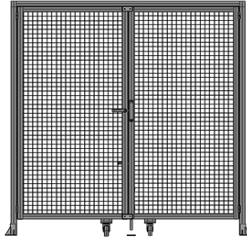

**J2 - Single Panel Doors - No Frame or Header**

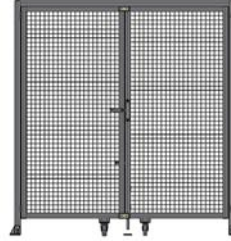

**J3 - Single Panel Doors - Robust Frame W/ Header**



**J4 - Single Panel Doors - Robust Frame W/O Header**

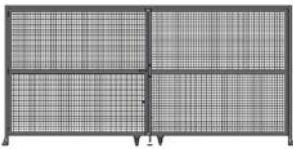

**J5 - Double Panel Doors W/ Header**

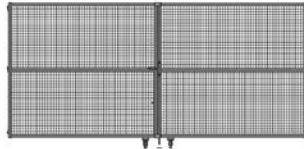

**J6 - Double Panel Doors - No Frame or Header**

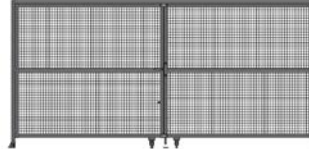

**J7 - Double Panel Doors - Robust Frame W/ Header**

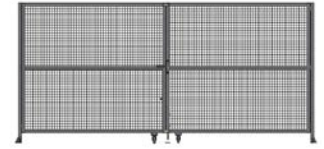

**J8 - Double Panel Doors - Robust Frame W/O Header**

## Handle Options (Handle)



**T - Turn Handle and Stop**

Quarter turn handle with a cam that goes through the door post like a traditional door handle. On the opposite end is a cam that engages with a door stop.



**L - Locking Turn Handle and Stop**

Locking turn handle same as the ¼ turn "T", but with a key lock.



**D - D Hand W/ Ball Catch on Top**

Door is opened/closed by pulling/pushing on handle. Door catch holds the door in closed position.



**B - No Handle W/ Ball Catch on Top**

Door is opened/closed by pulling/pushing on frame. Door catch holds the door in closed position.

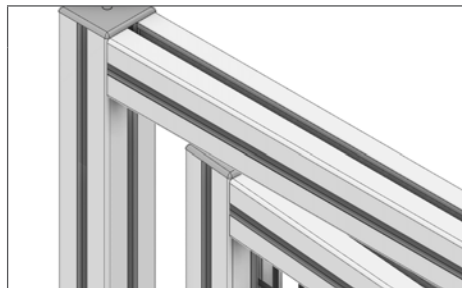

**Z - No Handles**

**Other Handles Available**



Contact Us for More Info

## Insert Options

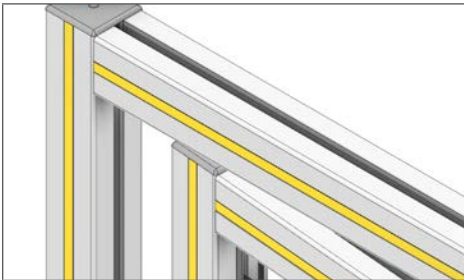

**Y - Yellow Insert**

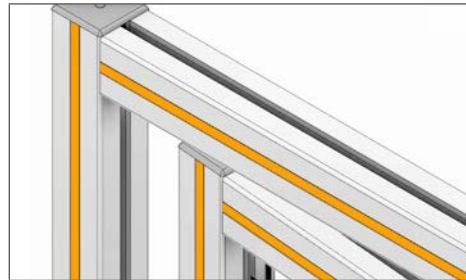

**O - Orange Insert**

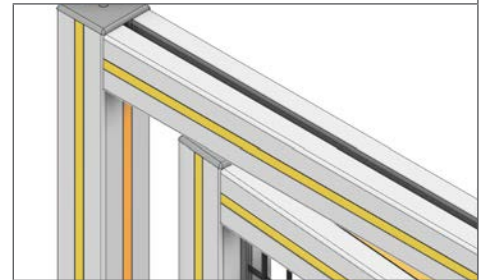

**J - Orange Insert on Inside, Yellow on Outside**

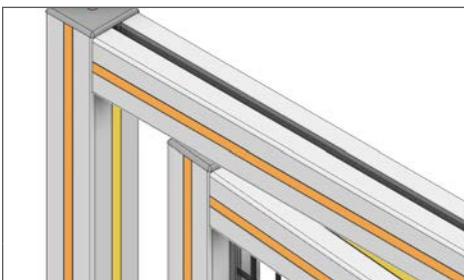

**Q - Yellow Insert on Inside, Orange on Outside**

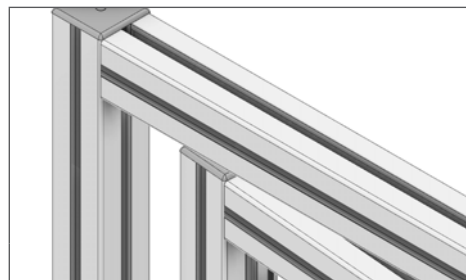

**Z - None**



**Powder Coating Available.  
Contact Us for More Information**

## Panel Material



**M - Mesh**

1" x 1" 12AWG welded wire mesh, with a PVC coating, and a pattern of 1" x 1" on the wire center lines.



**P - Polycarbonate**

¼" clear paneling made of polycarbonate material.

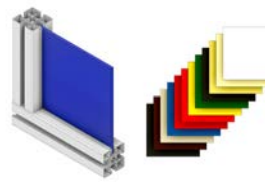

**U, G, B, W - PVC Board**

PVC foam board compressed for a smooth surface and light weight material. Comes in a large variety of colors. White, blue, black, and gray are our standards, but many others are available.



**L - Aluminum Composite Panel**

Aluminum board with a painted silver metallic surface and a plastic corrugated core.



**C - Aluminum Panel**

Solid 0.09" non-anodized aluminum paneling.



**R - No Panel with Retainer Insert**

This is a plastic insert commonly used to hold ¼" paneling into the T-slot.



**N - No Mesh with Retainer Insert**

This is a plastic insert commonly used to hold 1" mesh into the T-slot.



**Z - No Panel**

## Foot Types

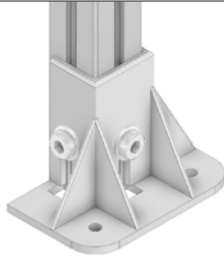

**T - Three Sided Foot**

Foot with pad and anchor points on three of the four Sides of the guard. Comes standard on doors with flush side in the door. Comes standard on guard with flush side on inside of guard. Can easily be field rotated.



**Z - No Foot**

Aluminum profile go to the floor. No support or anchor point.

## Assembled or Kit

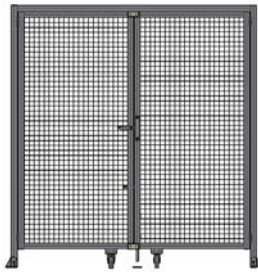

**A - Assembled**

We build the fence sections to the print.

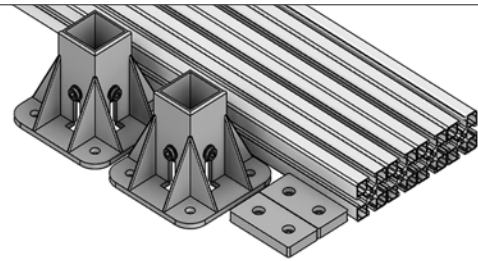

**K - Kit**

Typically, a lower cost alternative where the customer will assemble the wall section themselves.

## Automated Solutions Available

Guarding can be equipped with actuators, linear guides, sensors, lights, and other components creating fully automated solutions such as:

- Vertical and horizontal doors
- Inspection drawers
- Weld curtains

Contact one of our knowledgeable technical staff for more information.



## How to Order

<b>K1</b>	-	<b>1000</b>	-	<b>Y</b>	<b>F</b>	<b>T</b>
Type		Height		Insert	Foot	Assembly

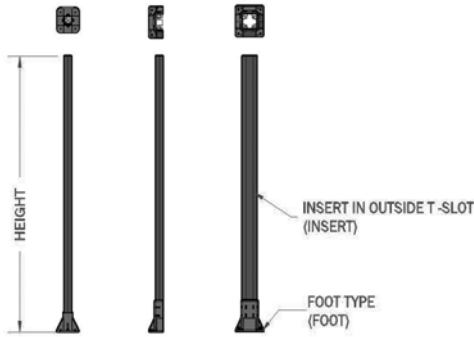

Guard Type (Type)
K1 - Post 45 x 45
K2 - Post 45 x 90
K3 - Post 90 x 90

Height
Height of Post (MM)

Insert
Y - Yellow Insert
O - Orange Insert
Z - None
Powder coated extrusion available on request Shipped loose

Foot Type (Foot)
F - Four Sided Foot Min sweep = 150MM
T - Three Sided Foot Can be adjusted at install
P - Two Inch Pad and Angle Bar
A - Single Small Angle 45 x 90
Z - No Foot

Assembled or Kit (Assembly)
A - Assembled Factory assemblies
K - Kit Customer assemblies

### Post With Foot Types

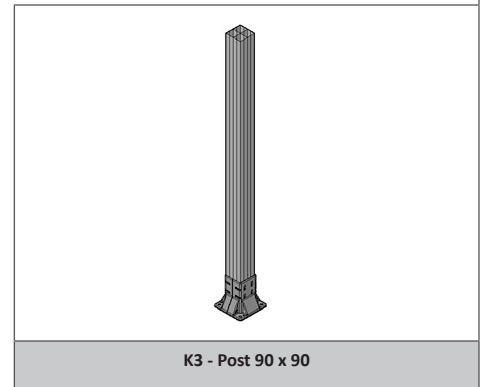
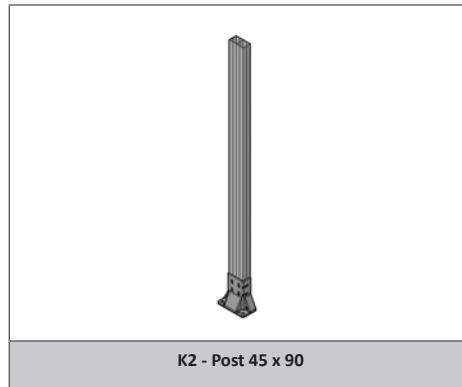
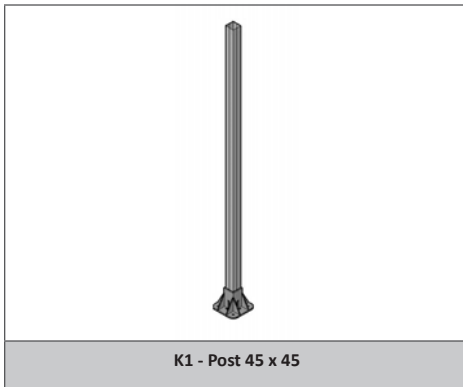

### Insert Options

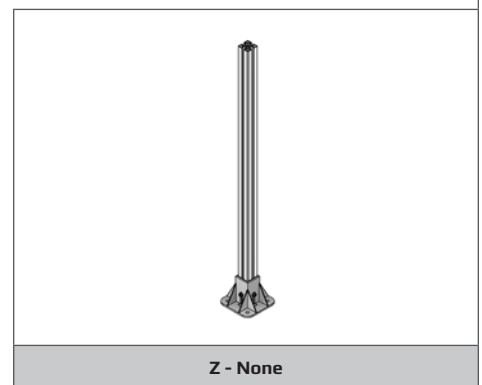
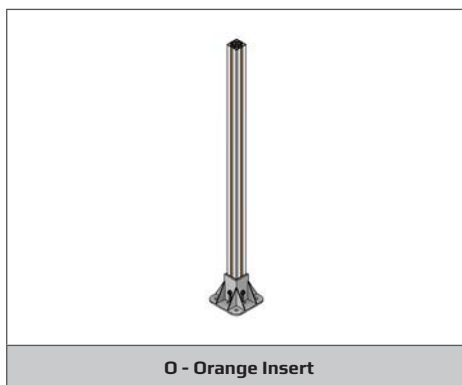
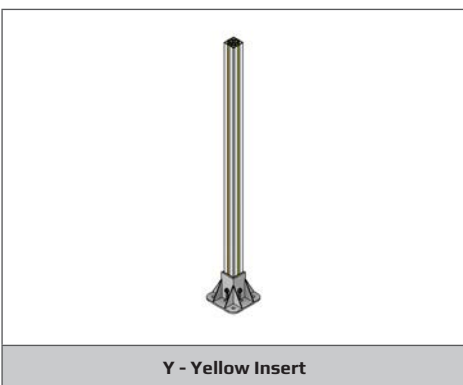

## Foot Types

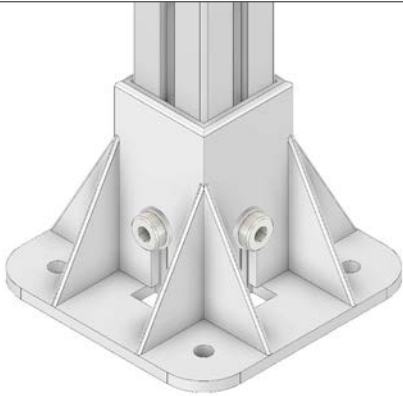

**F - Four Sided Foot**

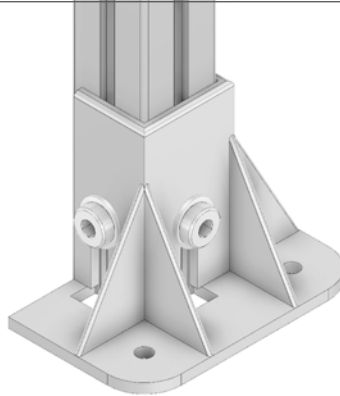

**T - Three Sided Foot**



**P - Two Inch Pad and Angle Bar**

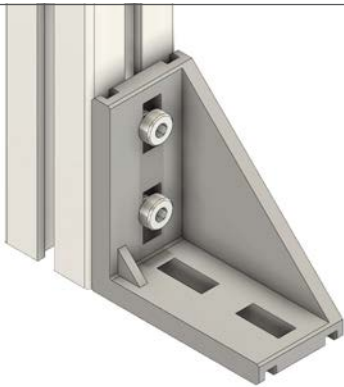

**A - Single Small Angle**



**Z - No Foot**

## Floor Mounting Hardware



3/8 IN. x 3 IN. Wedge Anchor - # 24-383-0  
3/8 IN. x 3 IN. Anchor Bolt - # 24-383S-0

For the following options:

- P - Two Inch Pad and Angle Bar
- A - Single Small Angle

1/2 IN. x 3 3/4 IN. Wedge Anchor - # 24-123-0

1/2 IN. x 3 IN. Anchor Bolt - # 24-123S-0

For the following options:

- F - Four Sided Foot
- T - Three Sided Foot

## Assembled or Kit

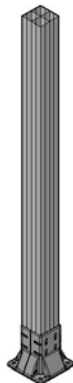

**A - Assembled**

We build the fence sections to the print.

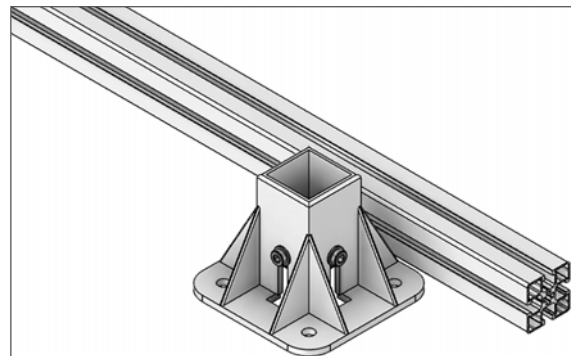

**K-Kit**

Typically, a lower cost alternative where the customer will assemble the wall section themselves.



## How to Order

<b>L1</b>	<b>-</b>	<b>1000</b>	<b>-</b>	<b>T</b>	<b>Y</b>	<b>T</b>
Type		Length		Connection	Insert	Assembly

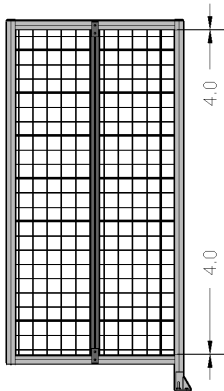
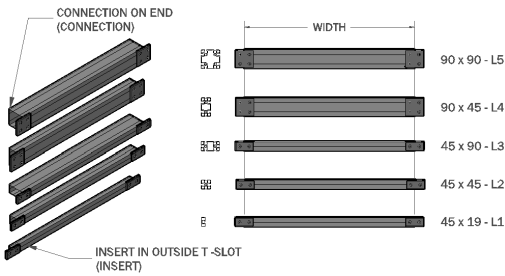

Guard Type (Type)
<b>L1 - 45 x 19</b> (Half strap)
<b>L2 - 45 x 45</b>
<b>L3 - 45 x 90</b>
<b>L4 - 90 x 90</b>

Length
<b>Length of Bar or Half Strap (MM)</b>

Connection on Both Ends
<b>T - Tie Plates (2)</b> 45 x 90
<b>P - Tie Plates (2)</b> 90 x 90
<b>A - 45 x 45 Angles</b> Good on L2
<b>B - 45 x 90 Angles</b> Good on L2 or L3
<b>C - 45 x 90 Angles</b> Good on L2 or L3
<b>H - Hinge for the 45MM Side</b> Good on L2 or L3
<b>Z - Nothing</b>

Insert
<b>Y - Yellow Insert</b> Two sides
<b>O - Orange Insert</b> Two sides
<b>Z - None</b>
Powder coated extrusion available on request Shipped loose

Assembled or Kit (Assembly)
<b>A - Assembled</b> Factory assemblies
<b>K - Kit</b> Customer assemblies

**Note**
When using L1 inside a mesh panel as shown in the picture below please allow for a 4MM gap on each side
Ex: If panel height is 1835MM, the half strap height would be 1827MM

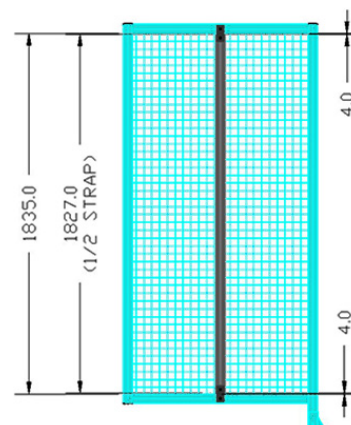
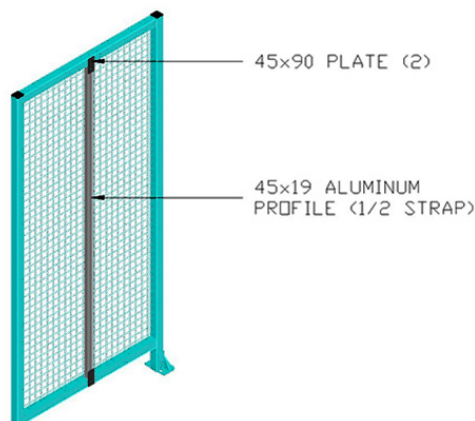

## Bar and Half Strap Types

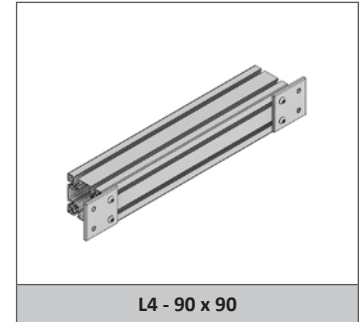
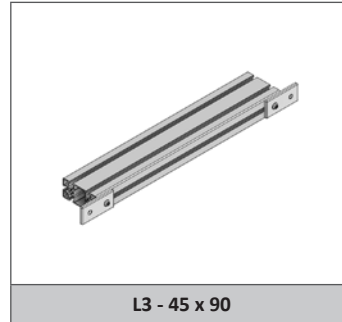
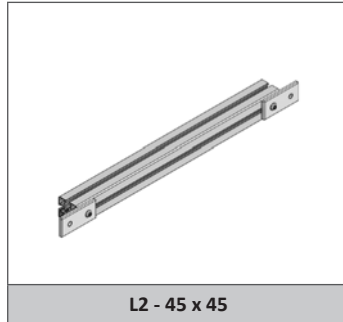
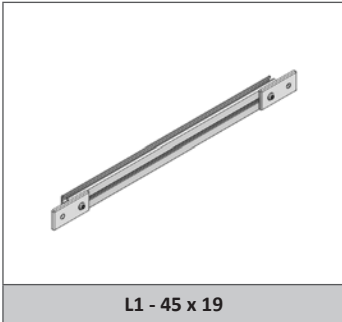

## Connections on Both Ends

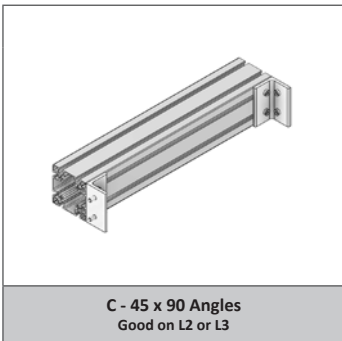
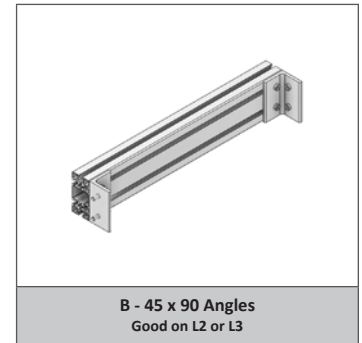
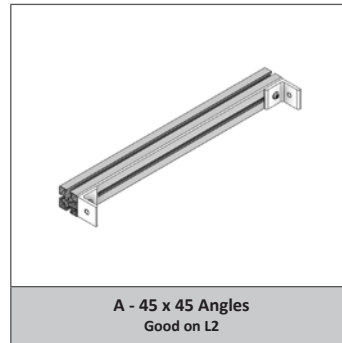
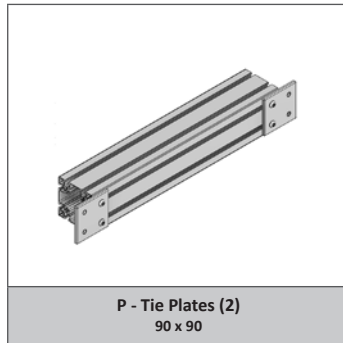
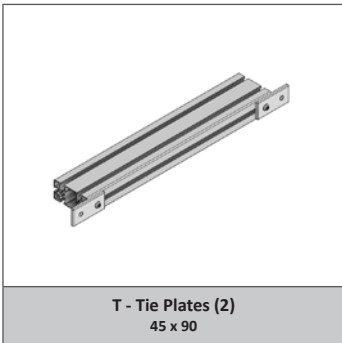

**Other Connections Available**

Contact Us for More Info

## Insert Options

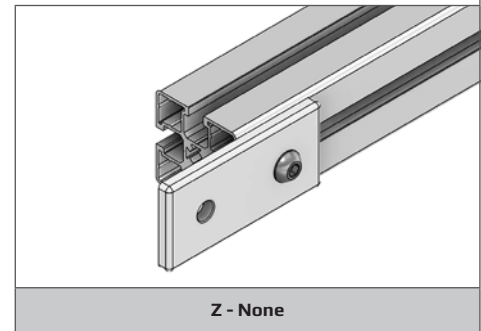
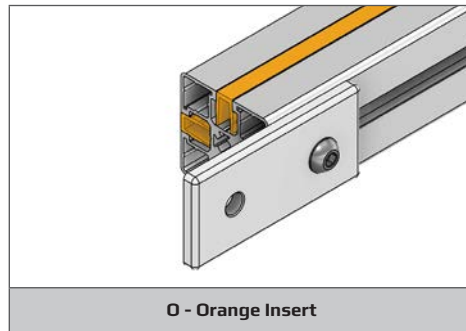
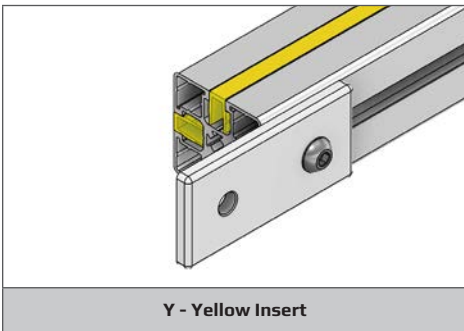

## Assembled or Kit

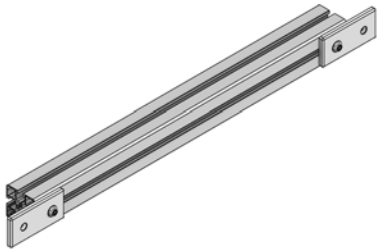

**A - Assembled**  
We build the fence sections to the print.

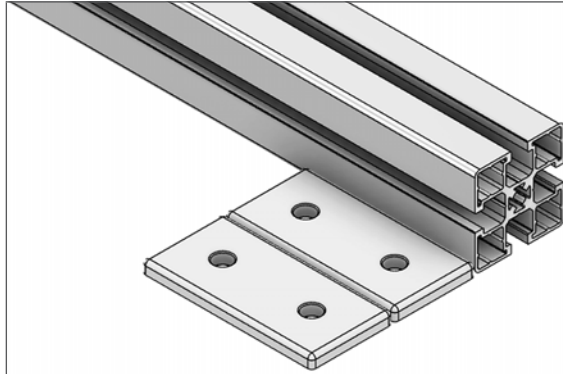

**K - Kit**  
Typically, a lower cost alternative where the customer will assemble the wall section themselves.

## Buy Online

You can purchase Mod-Guard and Modular Solutions products online at [www.TheAutomationWarehouse.com](http://www.TheAutomationWarehouse.com)

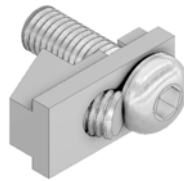
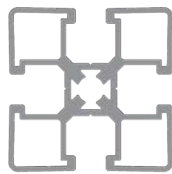

**Button Head Cap Screw - Zinc Plated**

	Length	M4 X 0.70	M5 X 0.80	M6 X 1.00	M8 X 1.25
	8MM	M4X8BHCS-0			
	10MM	M4X10BHCS-0	M5X10BHCS-0	M6X10BHCS-0	M8X10BHCS-0
	12MM	M4X12BHCS-0	M5X12BHCS-0	M6X12BHCS-0	M8X12BHCS-0
	14MM		M5X14BHCS-0		
	16MM	M4X16BHCS-0	M5X16BHCS-0	M6X16BHCS-0	M8X16BHCS-0
	18MM		M5X18BHCS-0		M8X18BHCS-0
	19MM				
	20MM	M4X20BHCS-0	M5X20BHCS-0	M6X20BHCS-0	M8X20BHCS-0
	22MM		M5X22BHCS-0		M8X22BHCS-0
	25MM	M4X25BHCS-0	M5X25BHCS-0	M6X25BHCS-0	M8X25BHCS-0
	30MM	M4X30BHCS-0	M5X30BHCS-0	M6X30BHCS-0	M8X30BHCS-0
	35MM		M5X35BHCS-0	M6X35BHCS-0	M8X35BHCS-0
	40MM		M5X40BHCS-0	M6X40BHCS-0	M8X40BHCS-0
	45MM		M5X45BHCS-0	M6X45BHCS-0	M8X45BHCS-0
50MM	M4X50BHCS-0	M5X50BHCS-0	M6X50BHCS-0	M8X50BHCS-0	

**Button Head Cap Torx Screw - Zinc Plated**

	Length	M8 X 1.25
	16MM	M8X16BHCS-2
	25MM	M8X25BHCS-2
	35MM	M8X35BHCS-2

**Rectangular Nuts W/ Position Fix Spring - Zinc Plated**

	Length	M8 X 1.25
	16MM	M8X16BHCS-4
	25MM	M8X25BHCS-4
	35MM	M8X35BHCS-4

**Flat Head Cap Screw - Countersunk - Zinc Plated**

	Length	M4 X 0.70	M5 X 0.80	M6 X 1.00	M8 X 1.25
	8MM	M4X8FHCS-0			
	10MM	M4X10FHCS-0	M5X10FHCS-0	M6X10FHCS-0	M8X10FHCS-0
	12MM	M4X12FHCS-0	M5X12FHCS-0	M6X12FHCS-0	M8X12FHCS-0
	14MM		M5X14FHCS-0		
	16MM	M4X16FHCS-0	M5X16FHCS-0	M6X16FHCS-0	M8X16FHCS-0
	18MM		M5X18FHCS-0		
	20MM	M4X20FHCS-0	M5X20FHCS-0	M6X20FHCS-0	M8X20FHCS-0
	22MM				M8X22FHCS-0
	25MM	M4X25FHCS-0	M5X25FHCS-0	M6X25FHCS-0	M8X25FHCS-0
	30MM	M4X30FHCS-0	M5X30FHCS-0	M6X30FHCS-0	M8X30FHCS-0
	35MM		M5X35FHCS-0	M6X35FHCS-0	M8X35FHCS-0
	40MM		M5X40FHCS-0	M6X40FHCS-0	M8X40FHCS-0
	45MM		M5X45FHCS-0	M6X45FHCS-0	M8X45FHCS-0
	50MM		M5X50FHCS-0	M6X50FHCS-0	M8X50FHCS-0

**Low Head Socket Cap Screw - Zinc Plated**

	Length	M4 X 0.70	M5 X 0.80	M6 X 1.00	M8 X 1.25
	10MM		M5X10LHSCS-0		
	12MM		M5X12LHSCS-0	M6X12LHSCS-0	M8X12LHSCS-0
	14MM				M8X14LHSCS-0
	16MM	M4X16LHSCS-0	M5X16LHSCS-0	M6X16LHSCS-0	M8X16LHSCS-0
	18MM			M6X18LHSCS-0	M8X18LHSCS-0
	20MM		M5X20LHSCS-0	M6X20LHSCS-0	M8X20LHSCS-0
	22MM			M6X22LHSCS-0	M8X22LHSCS-0
	25MM		M5X25LHSCS-0	M6X25LHSCS-0	M8X25LHSCS-0
	30MM		M5X30LHSCS-0	M6X30LHSCS-0	M8X30LHSCS-0
	35MM	M4X35LHSCS-0	M5X35LHSCS-0	M6X35LHSCS-0	M8X35LHSCS-0
	40MM		M5X40LHSCS-0	M6X40LHSCS-0	M8X40LHSCS-0
	45MM		M5X45LHSCS-0	M6X45LHSCS-0	M8X45LHSCS-0
	50MM		M5X50LHSCS-0	M6X50LHSCS-0	M8X50LHSCS-0

**Square Nuts W/ Position Fix Spring - Zinc Plated**

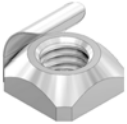
	Thread	Part Number
	M4	M45-PF
	M5	M55-0
	M6	M65-0
	M8	M85-0

**Square Nuts - Zinc Plated**

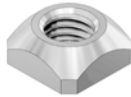
	Thread	Part Number
	M4	M45-0
	M5	M55-0
	M6	M65-0
	M8	M85-0

**Rectangular Nuts W/ Position Fix Spring - Zinc Plated**

	Thread	Part Number
	M5	M5L-PF
	M6	M6L-PF
	M8	M8L-PF

**Rectangular Nuts - Zinc Plated**

	Thread	Part Number
	M4	M4L-0
	M5	M5L-0
	M6	M6L-0
	M8	M8L-0

**Hex Nuts - Zinc Plated**

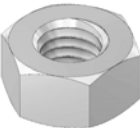
	Thread	Part Number
	M4	M4H-0
	M5	M5H-0
	M6	M6H-0
	M8	M8H-0

**Serrated Flange Hex Nut - Zinc Plated**

	Thread	Part Number
	M4	M4F-0
	M5	M5F-0
	M6	M6F-0
	M8	M8F-0

### Standard Washer - Zinc Plated

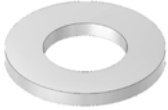
	Thread & Width Dia.	Part Number
	M4 X 8MM	M45MW-0
	M5 X 10MM	M55MW-0
	M6 X 12MM	M65MW-0
	M8 X 16MM	M85MW-0

### Lock Washers - Zinc Plated

	Thread	Part Number
	M4	M4LKW-0
	M5	M5LKW-0
	M6	M6LKW-0
	M8	M8LKW-0

### Wedge Anchor - Zinc Plated

	Thread X Length	M8 X 1.25
	3/8 x 3 IN.	24-383-0
	1/2 x 3-3/4 IN.	24-123-0

### Anchor Bolts - Zinc Plated

	Thread X Length	M8 X 1.25
	3/8 x 3 IN.	24-3835-0
	1/2 x 3 IN.	24-1235-0



**23-004-0**  
T-Handle Allen Wrench  
4MM



**23-005-0**  
T-Handle Allen Wrench  
5MM



**23-100-0**  
Torx Wrench



**23-508-150**  
Forming Tap  
M8 x 1.25 150MM Depth



**23-606-SD**  
Step Drill (7MM - 10MM)  
For M6 Screw



**23-608-SD**  
Step Drill (9MM - 14MM)  
For M8 Screw

**Profile**

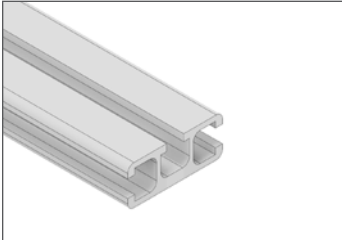

**10-4518.5-0**  
Aluminum Profile  
45MM X 18.5MM  
3-Slots

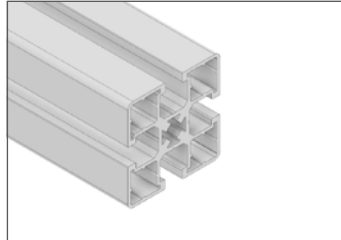

**10-4545-0**  
Aluminum Profile  
45MM X 45MM

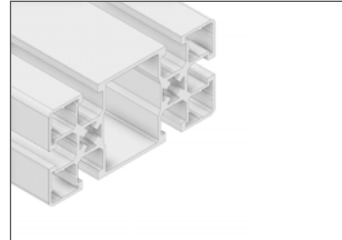

**10-4590-0**  
Aluminum Profile  
45MM X 90MM

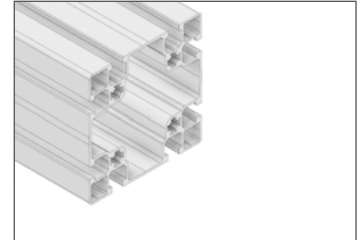

**10-9090-0**  
Aluminum Profile  
90MM X 90MM

**Feet and Casters**



**30-M8D50-1**  
Leveling Foot  
50MM Pad/ M8 Thread  
W/ Jam Nut



**30-M10D50-1**  
Leveling Foot  
50MM Pad/ M10 Thread  
W/ Jam Nut



**31-SM10D4-5**  
Stem Style Caster  
4 IN. Swivel-M10 Stem  
W/ Hardware



**31-SM10D4-7**  
Stem Style Caster  
4 IN. Swivel-M10 Stem  
W/ Lock & Hardware



**32-4590M10S-1**  
Solid Mounting Plate  
45 X 90  
W/ M10 Thread

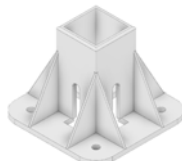

**33-4545-1**  
Mounting Foot  
4 Sided 45 X45  
11MM Anchor Holes  
W/ Hardware

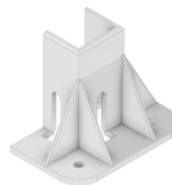

**33-45453S-1**  
Mounting Foot  
3 Sided 45 X45  
11MM Anchor Holes  
W/ Hardware



**33-4590-1**  
Mounting Foot  
4 Sided 45 X 90  
11MM Anchor Holes  
W/ Hardware

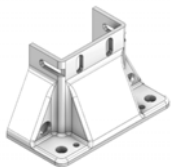

**33-45903S-7**  
Mounting Foot- 3 Sided  
45 X 90 105MM Tall  
12MM Anchor Holes  
W/ Hardware



**33-9090-1**  
Mounting Foot 4 Sided  
90 X 90  
170MM Tall  
12MM Anchor Holes  
W/ Hardware











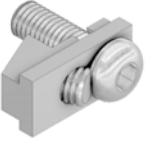
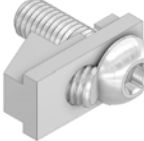
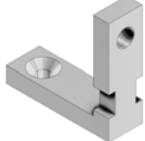

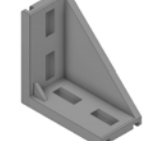









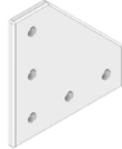

**34-150-1**  
Support Angle Bracket  
150MM  
W/ Hardware



**34-270-1**  
Support Angle Bracket  
270MM  
W/ Hardware

**Connectors**

				
<p><b>41-002-0</b> Speedlock Hidden Profile Connector - M5 Socket</p>	<p><b>41-002-2</b> Speedlock Hidden Profile Connector - Torx</p>	<p><b>41-001-0</b> Hidden Profile Connector M W/ Hardware</p>	<p><b>40-110-1</b> Gusset Bracket 45MM X 45MM W/ Hardware</p>	<p><b>40-120-1</b> Gusset Bracket 45MM X 90MM W/ Hardware</p>
				
<p><b>40-130-1</b> Gusset Bracket 90MM X 90MM W/ Hardware</p>	<p><b>40-210-0</b> Gusset Cover Cap Black 45MM X 45MM Cap For 40-110-1</p>	<p><b>40-220-0</b> Gusset Cover Cap Black 45MM X 90MM Cap For 40-120-1</p>	<p><b>40-230-0</b> Gusset Cover Cap Black 90MM X 90MM Cap For 40-130-1</p>	<p><b>40-34545-1</b> 45° Diagonal Brace 45MM X 45MM x 360MM W/ Hardware</p>
				
<p><b>41-110-1</b> Aluminum Tie Plate 45MM X 90MM W/ Hardware</p>	<p><b>41-120-1</b> Aluminum Tie Plate 90MM X 90MM W/ Hardware</p>	<p><b>41-130-1</b> Aluminum Tie Plate 45MM X 180MM W/ Hardware</p>	<p><b>41-140-1</b> Aluminum Tie Plate 90MM X 180MM W/ Hardware</p>	<p><b>41-150-1</b> Aluminum Corner Plate 135MM X 135MM W/ Hardware</p>
				
<p><b>41-154-1</b> Aluminum Corner Plate 135MM X 135MM W/ Hardware</p>	<p><b>41-170-1</b> Aluminum Tee Plate 135MM X 135MM W/ Hardware</p>	<p><b>41-180-1</b> Steel Tie Plate 45MM X 90MM W/ Hardware</p>	<p><b>41-300-1</b> 90MM T-Slot Bar W/ Hardware</p>	<p><b>41-400-1</b> Guarding Connection Removable Panel Lock Kit W/ Quick Release</p>
				
<p><b>41-410-1</b> Removable Panel Guarding Connection</p>	<p><b>41-420-1</b> Guard Fixing Angle W/ Hardware</p>	<p><b>41-420-2</b> Guard Fixing Angle W/ Torx Screws</p>	<p><b>42-001-1</b> 45MM X 45MM Pivot Joint - W/ Locking Handle &amp; Hardware</p>	<p><b>42-002-1</b> 45MM X 90MM Pivot Joint W/ Hardware</p>



**Door Hardware**











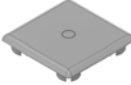

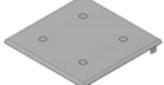
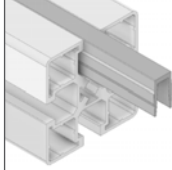
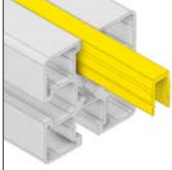



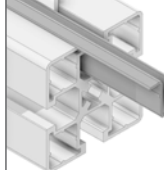



<b>50-010-0</b> 1/4 Turn L-Handle	<b>50-020-0</b> Locking 1/4 Turn L-Handle Keyed FH333	<b>50-100-1</b> Egress Handle W/ Integrated Cam Latch & Set Screw (-5 Offset)	<b>50-104-0</b> Cam Latch (+4 Offset)	<b>50-105-0</b> Cam Latch (-5 Offset) <i>Works with # 52-010-1</i>	<b>50-200-1</b> 180MM Pull Handle Gray W/ Hardware
<b>50-210-1</b> 120MM Pull Handle Gray W/ Hardware	<b>50-300-1</b> Compact Slam Latch Locking W/ Key & Hardware	<b>50-301-1</b> Emergency Unlock For Slam Latch	<b>50-310-1</b> Sliding Door & Swing Door Latch Locking W/ Key & Hardware	<b>51-000-1</b> Liftoff Hinge 45MM X 45MM W/ Hardware	<b>51-010-1</b> 45MM Hinge W/ Hardware
<b>52-010-1</b> Cam Latch Door Stop W/ Hardware <i>Works with # 50-105-0</i>	<b>52-110-1</b> Door Latch Single Stud - Metal W/ Hardware	<b>52-121-1</b> Ball Latch 70MM Brass W/ Hardware	<b>52-122-1</b> Ball Latch Angle Bracket W/ Hardware	<b>52-430-1</b> Door Stop W/ Hardware	<b>52-500-1</b> 24 IN. Cane Bolt W/ Hardware
				<b>Other Door Hardware Available</b>	
<b>55-010-1</b> Sliding Door Trolley Kit (Includes Spacer & Hardware)	<b>55-030-1</b> Sliding Door Trolley Stop For 10-800-0 W/ Hardware	<b>55-040-1</b> Sliding Door Guide W/ Hardware	<b>55-050-1</b> Sliding Door Hang rail Bracket W/ Hardware		
				<b>Contact Us for More Info</b>	

**Exceptional Shipping Preparation**

Guarding is naturally bulky especially when shipped assembled. Our shipping team takes great measures to make sure your guarding is properly prepared to make the journey to it's destination.

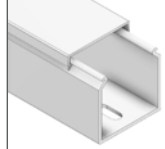

**Panel Elements**

					
<b>60-010-0</b> 45 X 45 End Cap Gray	<b>60-020-0</b> 45 X 90 End Cap Gray	<b>60-030-0</b> 90 X 90 End Cap Gray	<b>61-010-0</b> Cover Profile Gray PVC 2M	<b>61-010-2</b> Cover Profile Yellow PVC 2M	<b>61-010-3</b> Cover Profile Orange PVC 2M
					
<b>61-050-0</b> Cover Profile Anodized Aluminum 3M	<b>61-100-0</b> Panel Gasket For 5MM, 6MM & 1/4 IN. Panels Cut to Length	<b>61-120-0</b> Panel Retaining Insert (Anti-Rattle) 8 FT.	<b>62-000-0</b> Edge Protection Profile Cut to Length	<b>63-000-BK</b> 1 IN. Black Mesh (4 FT. X 8 FT.)	<b>63-050-BK</b> 1/2 IN. Black Mesh (4 FT. X 8 FT.)
					
<b>63-100-BL</b> 1/4 IN. Blue PVC Panel (4 FT. X 8 FT.)	<b>63-200-0</b> 1/4 IN. Clear Polycarbonate Panel (4 FT. X 8 FT.)	<b>63-300-0</b> 6MM Silver Metallic Aluminum Corrugated Plasticore Panel (4 FT. X 8 FT.)	<b>63-400-0</b> 1/8 IN. Aluminum Panel (4 FT. X 8 FT.)	<b>63-410-0</b> 1/4 IN. Aluminum Panel (4 FT. X 8 FT.)	<b>63-420-0</b> 0.08 IN. Aluminum Panel (4 FT. X 8 FT.)
					
<b>64-030-1</b> 45MM Wire Mesh Holder	<b>65-000-0</b> 45MM Plastic Conduit 38MM X 38MM - Gray 6.5 FT.	<b>66-100-1</b> Cable Block W/ M5 Bolt	<b>66-110-0</b> Cable Block 1/4 Turn 22MM Black	<b>66-4545-350</b> Cable Tray Support 45MM X 45MM Profile - 350MM Long	<b>66-4590-350</b> Cable Tray Support 45MM X 90MM Profile - 350MM Long

**Order Complete Guard Sections Online**

Modular Guarding Solutions Guard Sections are available for purchase online at



Choose from a variety of section types. Get CAD models, data sheets and more..

Scan to go to  
TheAutomationWarehouse.com

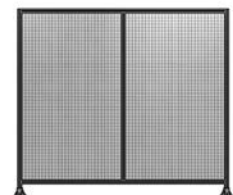

## Assembly of the Modular Guarding Solutions Profile and the Hidden Speedlock Fastener

The hidden fastener fits securely in 99% of all 8mm T-slot extrusion. By far the easiest and fastest locking mechanism.

- Provides for an extremely strong 90° connection
- Accurate location of the profile
- Integrated mounting aid
- Movable
- Low-cost due to minimal processing
- Can be used for all types of construction

### Assembly instructions

#### You Will Need

- Speedlock fastener
- 5mm Allen wrench (#23-005-0) or an impact driver and a 5MM Allen bit
- 4mm Allen wrench (#23-004-0)
- 2 pieces of Modular Solutions 45 Series profile
- Clamp

#### Step 1

Take the first piece of profile and clamp it to a table or solid surface.

#### Step 2

Install the Speedlock into the end of the first piece of profile in the center hole. Use T-Handle Allen Wrench # 23-005-0 or an impact driver with a 5MM Allen bit. Tighten the fastener in all the way. Draw it back a couple threads (about 2MM) so the fastener is a little loose.

#### Step 3

Slide the Speedlock Fastener that is installed into the first piece of profile into the T-slot of the second piece of profile and position into place.

#### Step 4

Using a 4MM Allen wrench (#23-004-0) tighten the set screw of the Speedlock to create the connection.

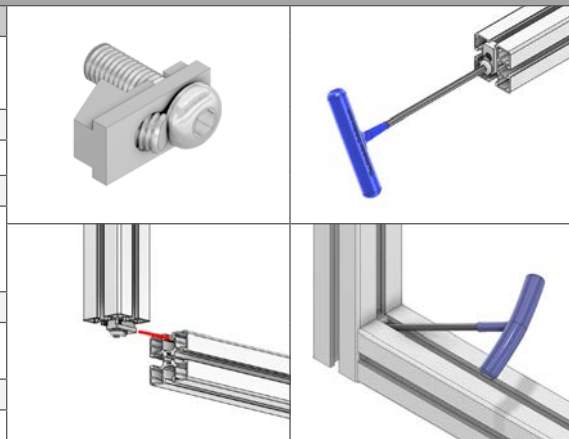

### Retaining Insert

Retaining Insert is used to secure solid panels and mesh within the T-slot. Simply cut to length and insert around the frame.

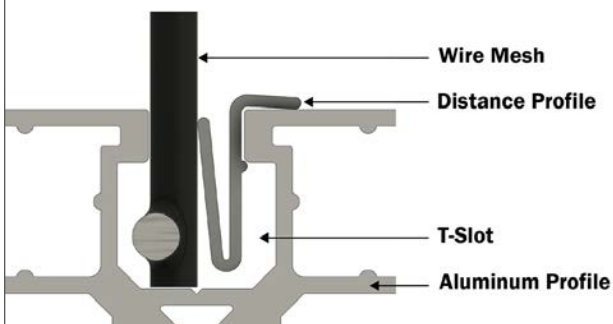

### Insert Profile

Designed for use with Modular Guarding Solutions' standard T-slot extrusion. Provides a smooth appearance that covers the T-slot.

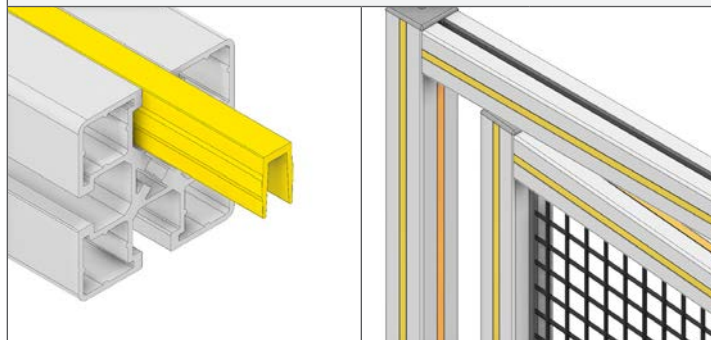

### Support Feet

Suitable for up to 45MM x 45MM profile. Use for holding guard frames to the floor using wedge anchors.

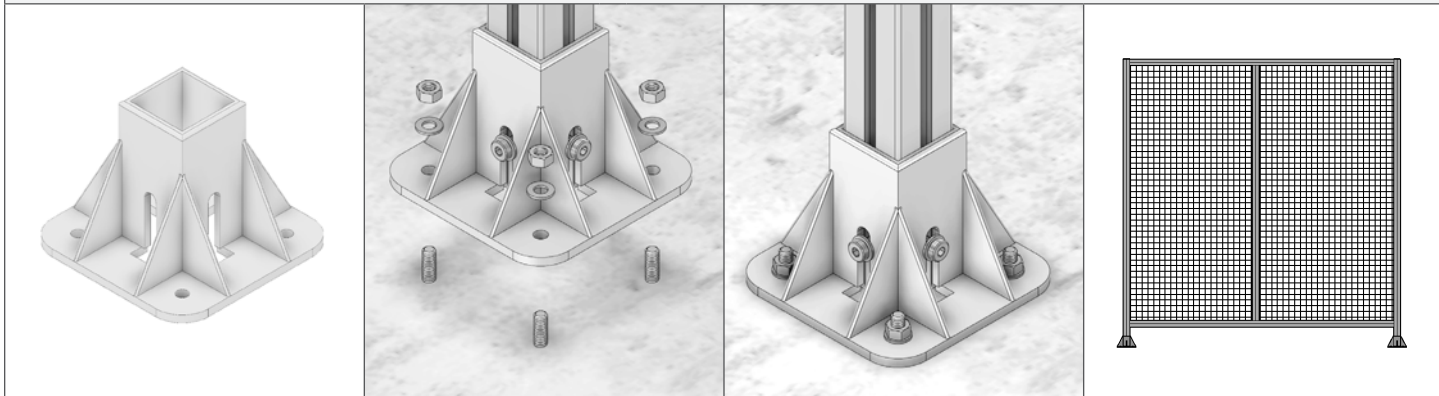

**Part Number Configurator - Online at [www.Mod-Guard.com](http://www.Mod-Guard.com)**

Use configurators and catalog to develop part number for individual wall sections. On average a customer will save 10% on cost, save 40% on delivery time, and there is no approval process with this method.

A. Use The on-line model configurator and develop both models and part numbers there.

B. Generate a part number using the on-line order guides, to help generate section part numbers quickly.

C. Contact technical support for Modular Guarding Solutions and they can help you develop part numbers for your applications.



Once your part number configuration is complete you, we can easily quote and sell individual wall sections like traditional components.

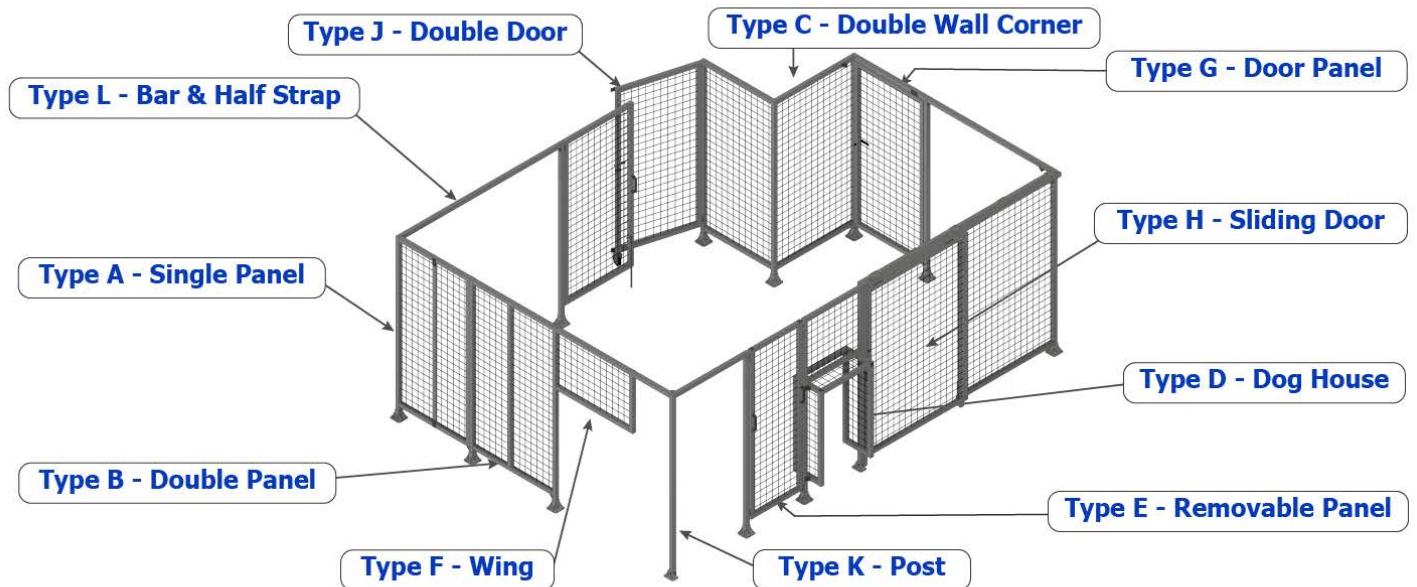

## Self Assembly Benefits

Our sales team and engineers will help with complete solutions. If your team is able to do the final assembly, we can supply a kit with all the parts and assembly drawings to you. Kits can be more easily shipped than complete assemblies.

Your packet will contain:

- A complete bill of materials
- Assembly and CAD detail drawings
- Tips of inserting hidden fasteners
- A list of recommended construction tools.

Most assembly instructions can be found in the catalog by looking up the part number or part name. If you need any further assistance please call to speak with a trained technical support representative.

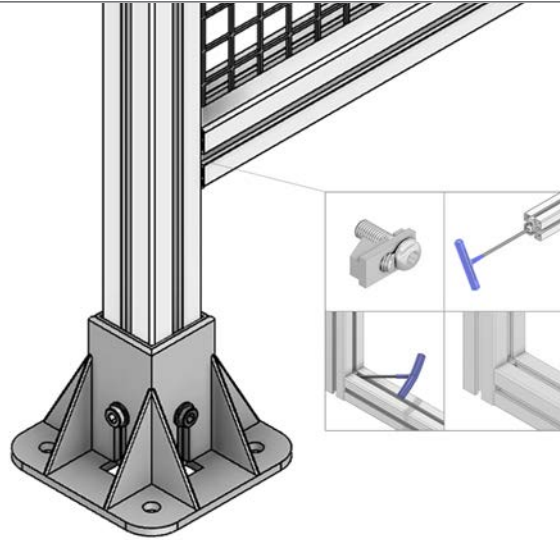

**Build anything fast using our large assortment of T-slot aluminum extrusion, along with various fastening options.**

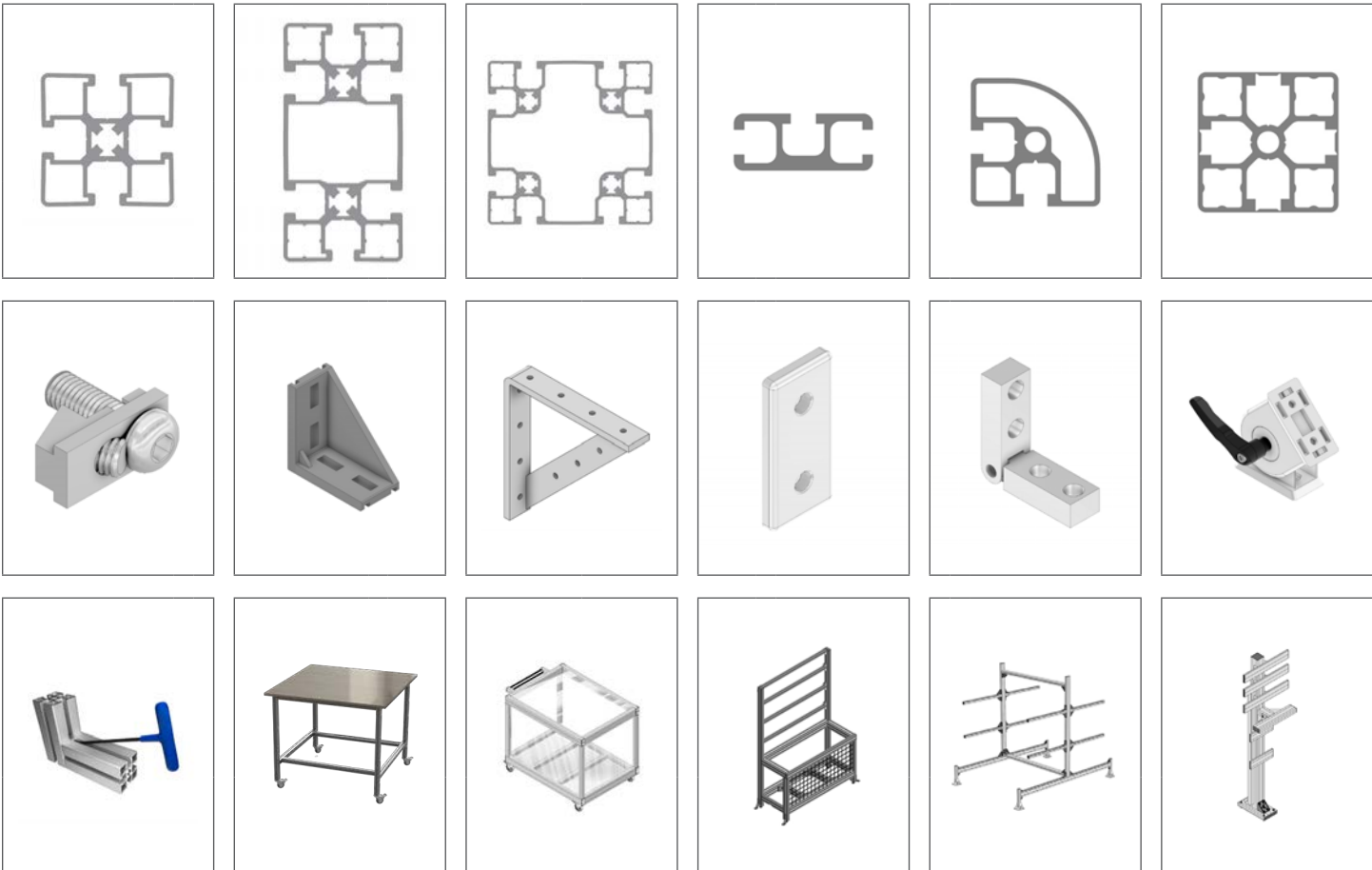

## Installation Option

Our installation team can assemble guarding on your shop floor after it is pre-fabricated at Modular Guarding Solutions.

To ensure a safe, efficient installation, we ask that a clear area be provided and that any portable equipment be removed from the installation area. We provide our own tools and safety equipment to properly complete the job.

The customer is responsible for supplying up-to-date drawings and or available information as requested.

Once the system is fully installed and/or operational, as described, Modular Guarding Solutions can provide support if needed.

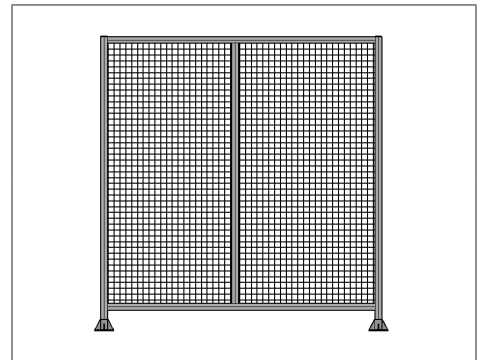
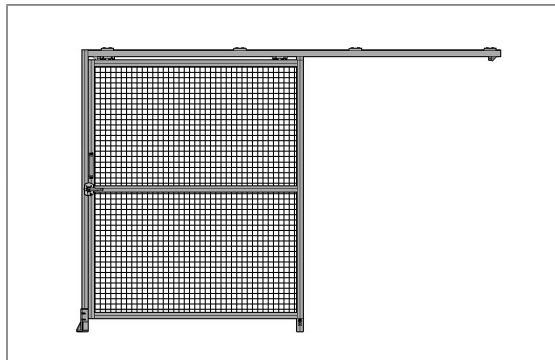
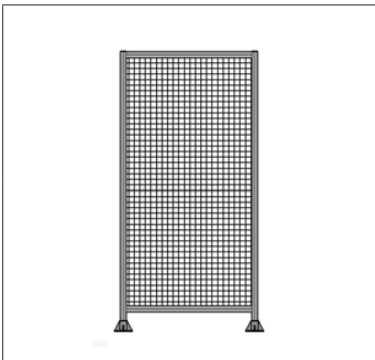
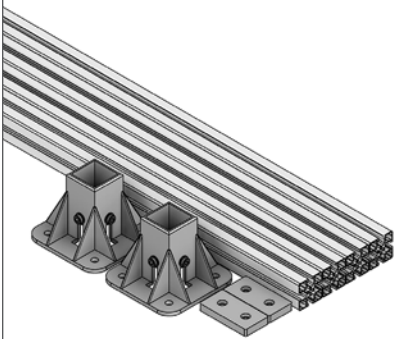

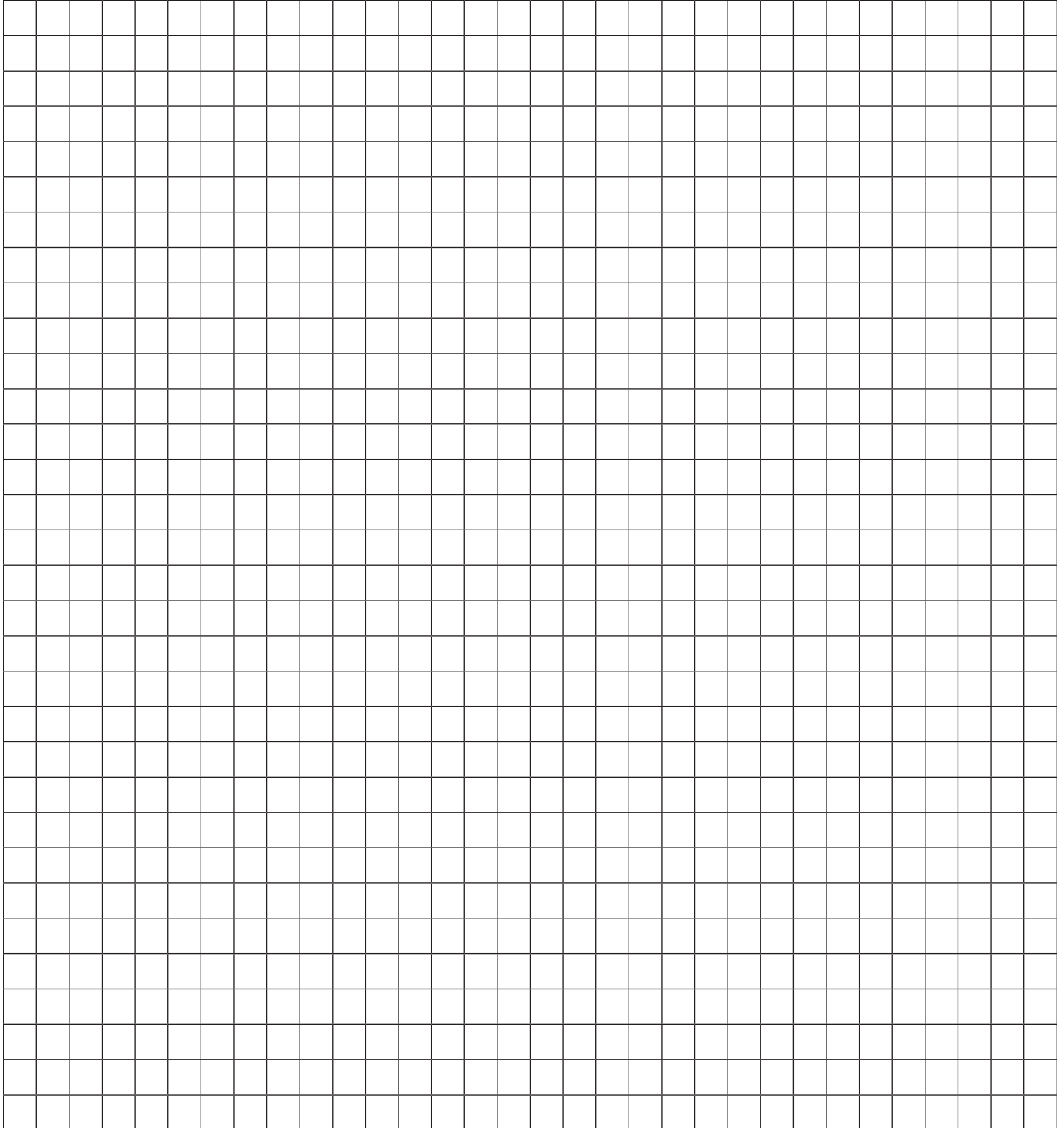

Modular Guarding Solutions can also create the custom guarding you need. We have the experience and available components to make the tailor-made guarding solution you require. Contact us for more information.

